

M 43 C

Long-Stroke Diesel Engines for Maximum Efficiency and High Reliability

6 • 7 • 8 • 9

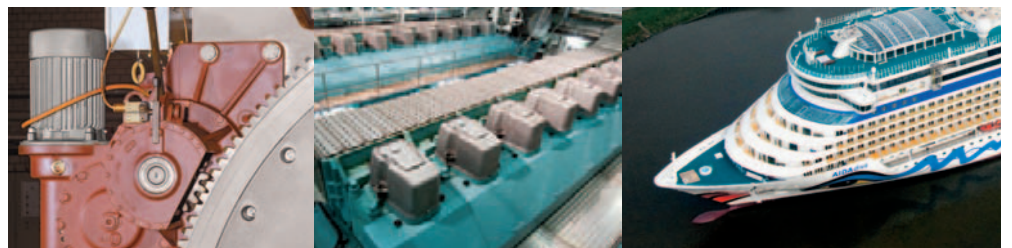
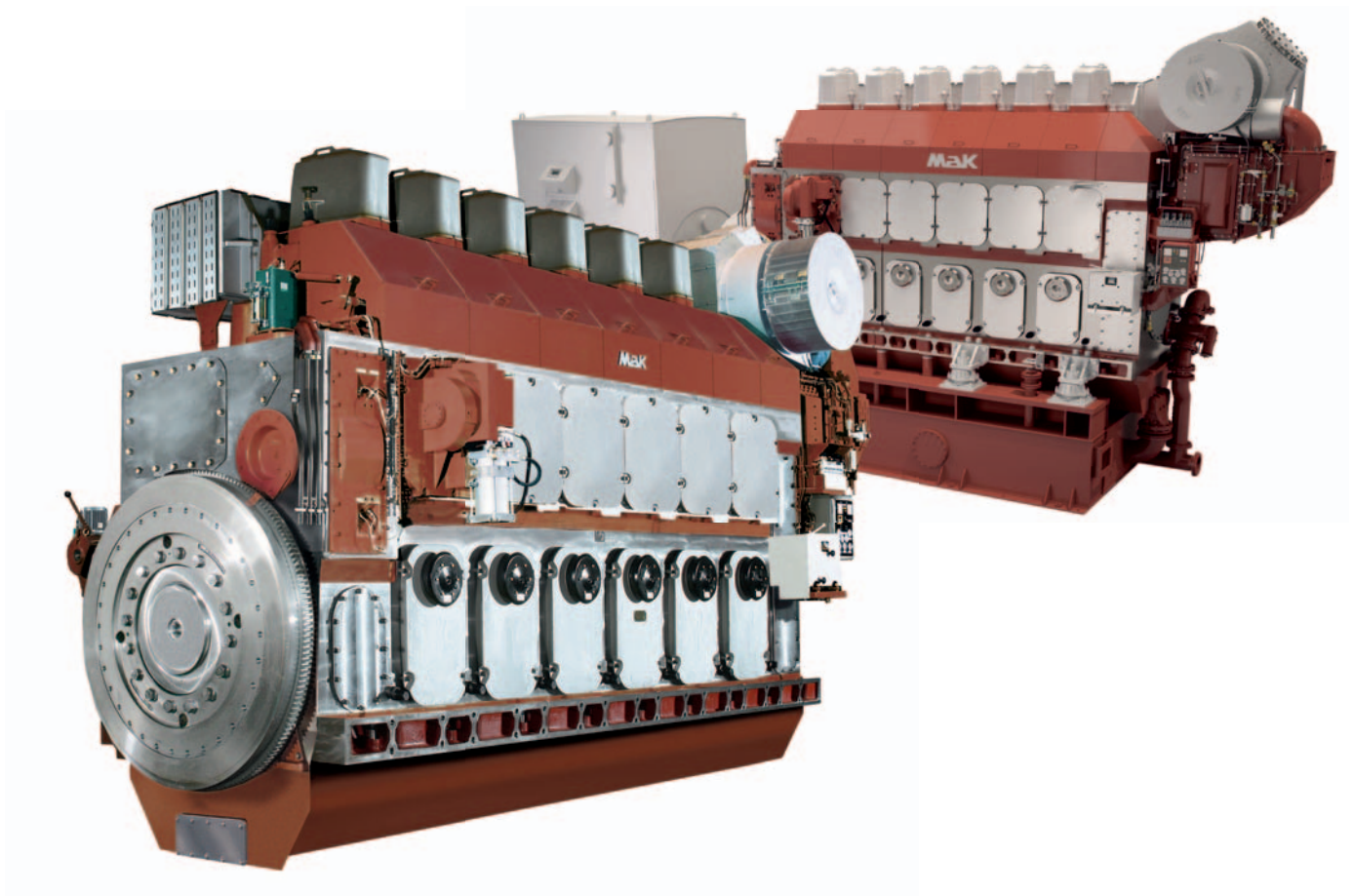

MAK

M 43 C – The World's Number One!

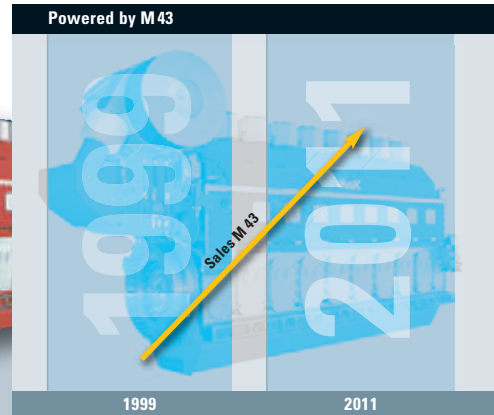
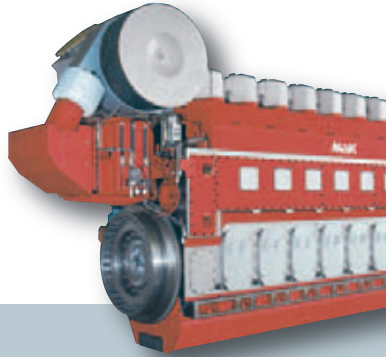

Since its introduction to the market, the MaK long-stroke engine series M 43 has achieved an outstanding position on the marine applications market as an in-line engine in 6, 7, 8 and 9 cylinder versions. More than 650 engines with a total power of more than 6,500 MW have already been sold, making the M 43 the market leader in the 5–9 MW power class. All the cylinder configurations have contributed to this market success. More than 90% of the marine engines run on heavy fuel within IMO regulatory limits.

The series has been particularly successful in the container feeder ship, RoPax vessel, RoRo ferry and cruise liner markets, but M 43 engines have also been installed in fishing vessels and specialized ships. Whether as a single-engine or multi-engine installation with mechanical transmission or as a generator drive unit for diesel-electric operation of electric motors, the M 43 has proved itself in service. Features, such as compact modular construction with less pipework, easy maintenance access to

components, low fuel and lubricating oil consumption as well as extended life between main component overhauls – these have been the factors most decisive for the M 43's high acceptance rate.

Power demands in marine propulsion, particularly in the container ship, RoRo ferry and cruise liner markets – as well as new technical solutions for components – were the reasons behind the development of the M 43 C engine.

The re-design concentrated on further improvement through increased component operational reliability, further simplification of maintenance, easier installation and simpler operation. Simplified engine control was also a major consideration. All these factors improved overall economy and are generally advantageous to the customer.

As a result, the market now has a high power-density series of engines of 5–9 MW.

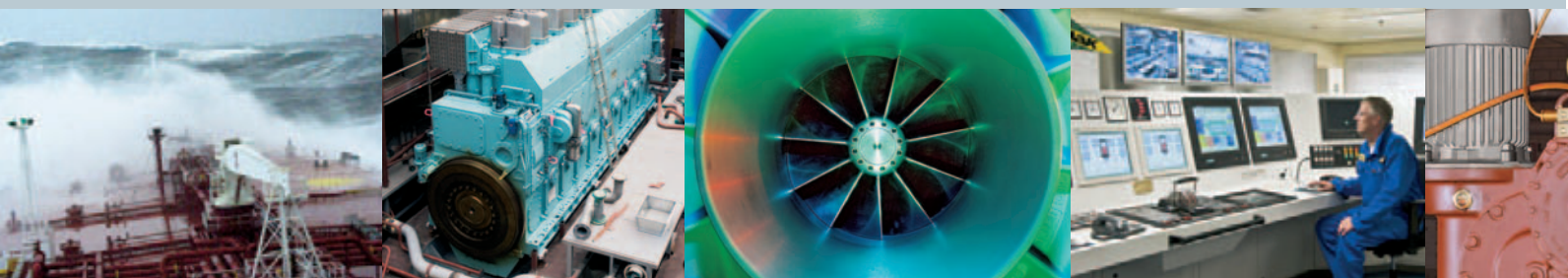

M 43 C – The Updated Number One!

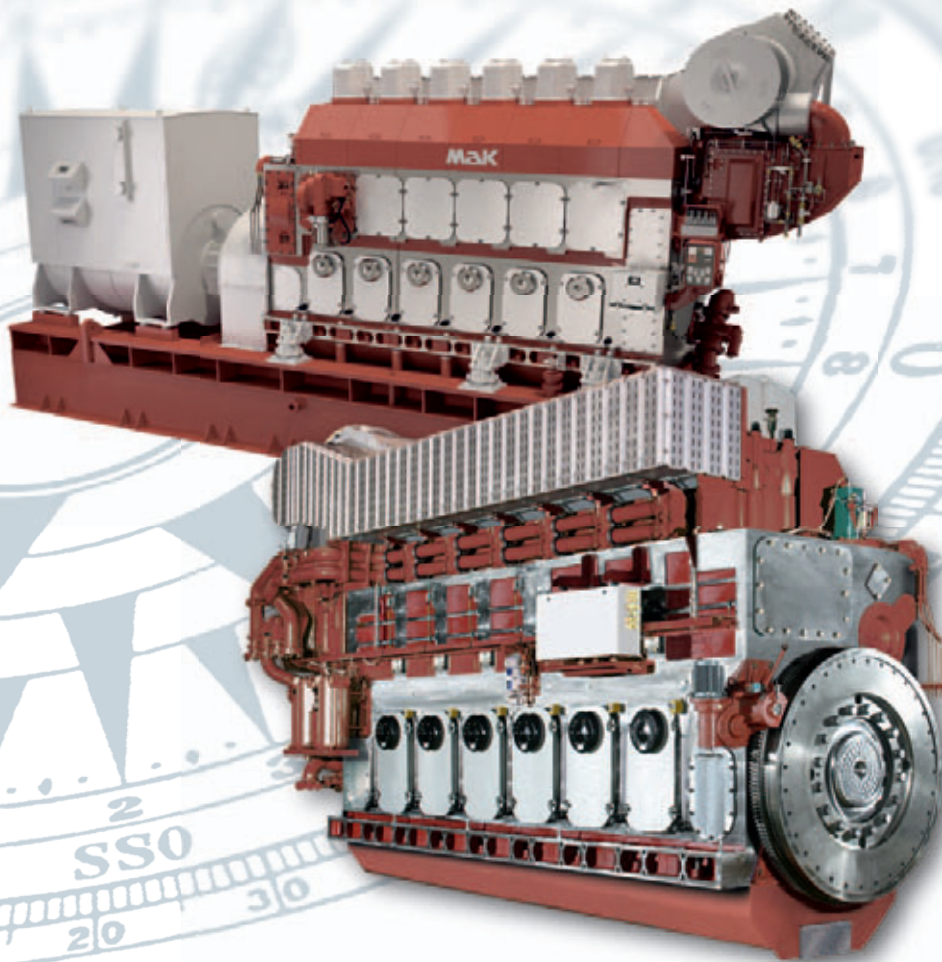

- ▶ M 43 C – Propulsion
- ▶ M 43 C – On-Board Power
- ▶ MaK Propulsion Package



M 43 C – Power for the Seven Seas!



Reliable propulsion
for ferries, RoPax vessels, cruise and passenger ships



Economic propulsion
for container ships and cargo vessels



M 43 C

M 43 C – Design Improvements

- Intelligent design
- State-of-the-art
- Reduced maintenance

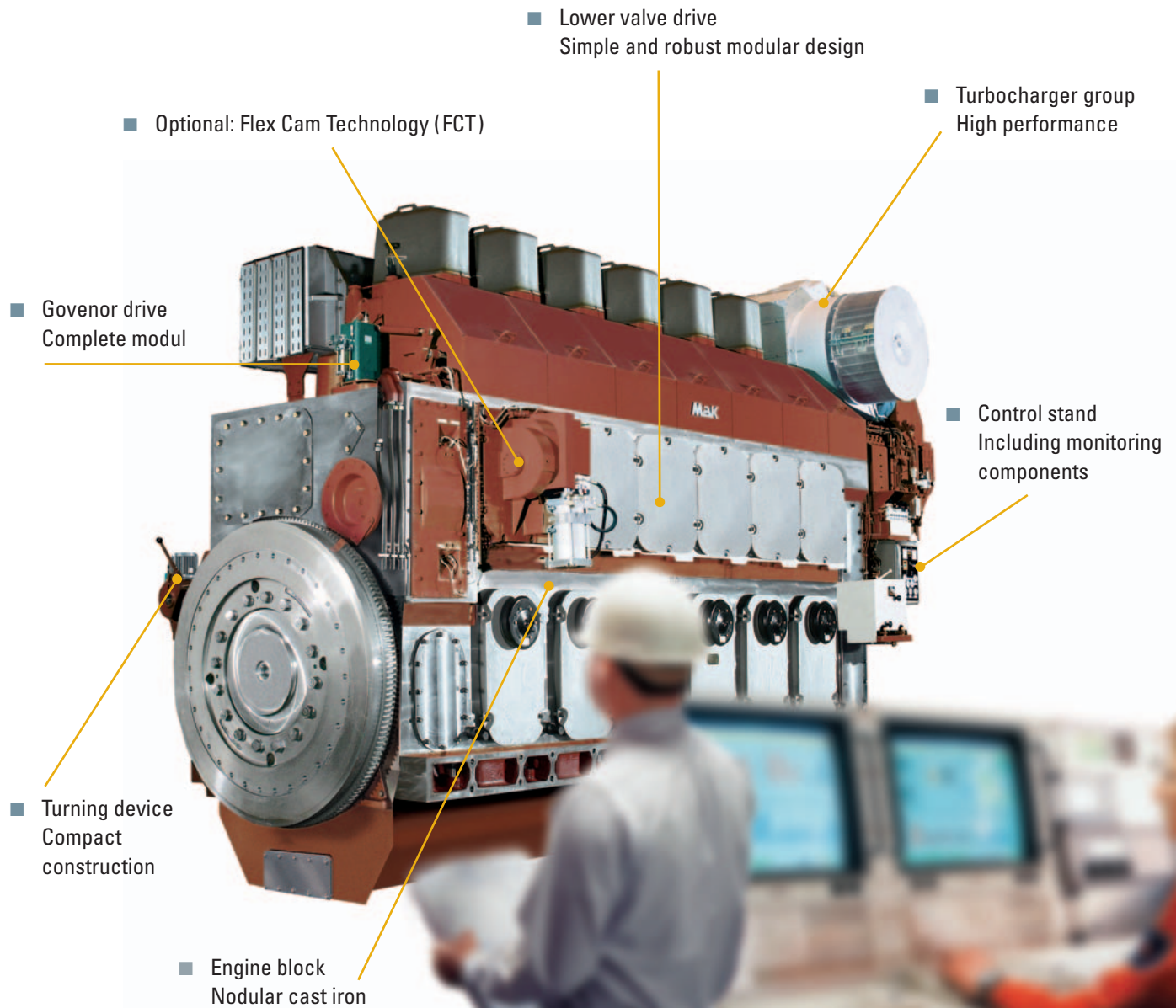

6, 7, 8, 9

M 43 C – Design Features

Engine with high safety level

The M 43 C is an engine with a high safety level, not only inside in terms of component life and availability but also with regard to external peripheral safety. SOLAS regulations are consistently observed. There is an explosion protection cover for the engine block, cladding for the complete fuel system from fuel filter to injection pump, while the exhaust gas and turbine casing, including the exhaust gas outlet casing, is in stainless steel – all part of an overall safety concept for the exhaust gas manifold.

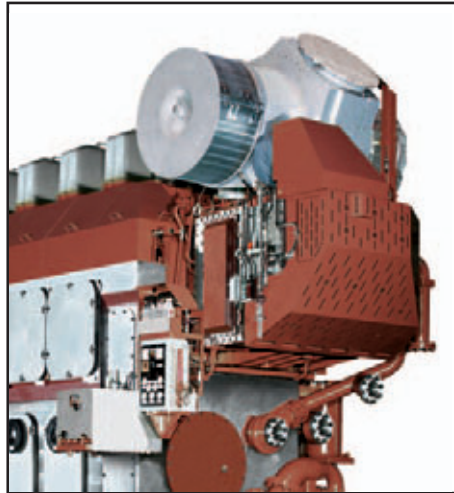

The turbocharger group consists of a high-performance turbocharger, a cartridge-type air cooler casing and charge air cooler

The cast charge air cooler casing forms a secure foundation for the turbocharger. The rigidity of the casing and a 40% increase in the base area for the turbocharger fastening ensure reliable, low vibration operation.

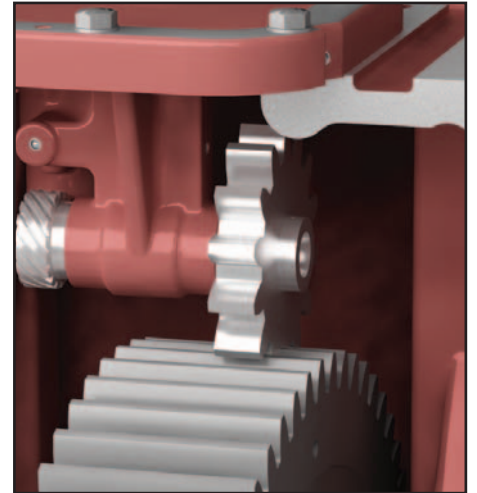

The governor drive

is of simple and robust design. The straight-tooth gearwheel drive is safe and requires no further adjustment. Designed as a complete module.

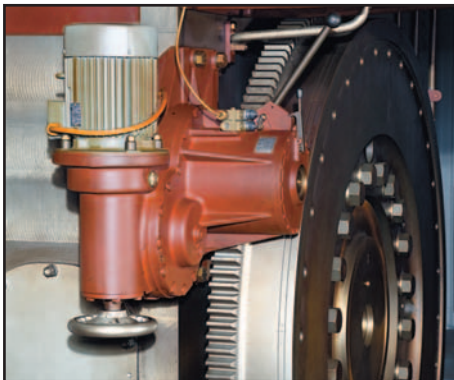

The turning device

is of compact construction, safely flanged onto the engine block. An irreversible gear and an engagement unit ensure simple operation and increased operational safety.

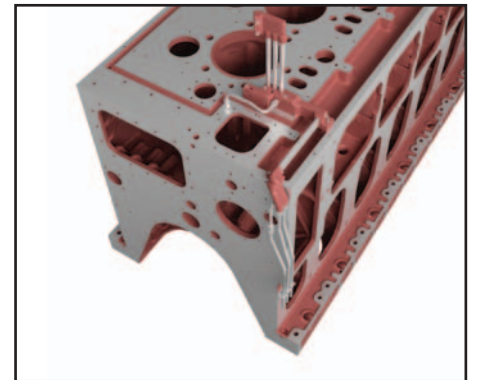

The media duct system

is integrated into the components wherever possible. External pipework has been reduced to a minimum. Maintenance requirements have been cut and work simplified by plug-in pipe connections.



M 43 C – Design Features

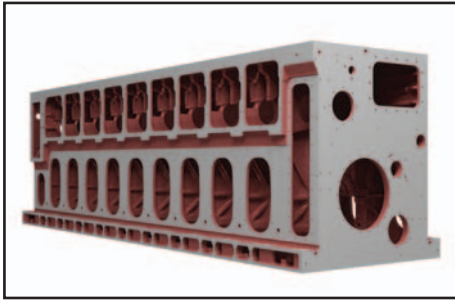

The engine block

consists of compact nodular cast iron components. There is a large inspection opening for sideways removal of the crankshaft vibration damper. Increased rigidity has been achieved by means of an integrated pump mounting plate. Fewer components mean fewer areas for sealing.

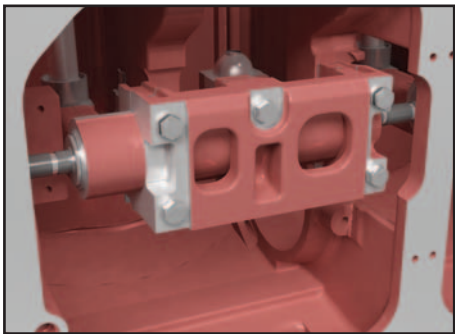

Lower valve drive and injection pump drive

“Keep it simple” – this design principle is consistently applied in this component. Of modular construction, the component is of simple and robust design and boasts increased operational safety because no adjustment work is necessary.



Control stand with monitoring components

All the engine performance data can be simply inspected on a new control stand arrangement with reliable, analog displays. The monitoring components are arranged centrally, directly above the control stand. This ensures increased operating convenience and simplified maintenance.

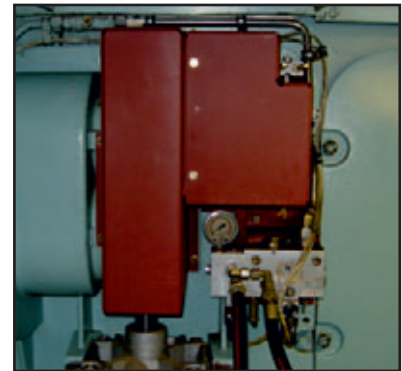

Flex Cam Technology (FCT); optional

The FCT system is a cornerstone of our emission reduction technology. Characteristic fuel injection and inlet valve timing are load controlled.

Valve timing changes at part load level raise effective compression and enhance complete combustion. In addition, shifting the relative position of the lever to the fuel cam increases injection pressure, producing a finer atomization of fuel in a load range where it is otherwise difficult to control smoke.

Cooled injection nozzles

The design of the cooled injection nozzle provides a number of advantages, particularly during heavy fuel operation.

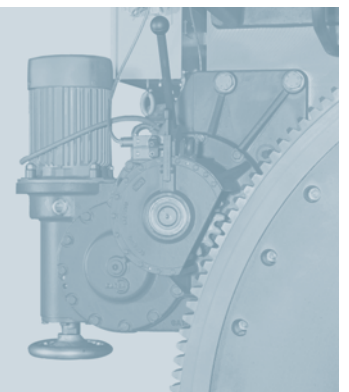

M 43 C – Economical from Installation to Operation

	TBO x 1000 h	Lifetime x 1000 h
Piston crown	15/30*	90
Piston skirt	-	60
Piston rings	-	30
Cylinder liner	-	60 / 90*
Cylinder head	15	-
Inlet valve	15	30
Exhaust valve	15	30
Nozzle element	-	4/8*
Pump element	-	15 / 20*
Main bearing	-	30
Big-end bearing	-	30

*MDO Operation

The above-mentioned data are not binding. They only serve as standard values. These standard values can be attained if the MaK operating and maintenance specifications are strictly observed and only MaK spare parts are used. Please consider as well the negative effect of bad fuel qualities.



HFO/MDO

Anticipated TBO and life

Long maintenance intervals and extended life form the basis for low operating costs.

Complete engine

The engine is marketed with standardized pump and filter equipment. The interfaces for the fuel, lubricating oil and cooling water systems are located at the free end of the engine for ease of connection.

Resilient foundation

The resilient foundation system can be assembled safely, simply and cheaply and ensures the damping of vibration and structure-borne noise.

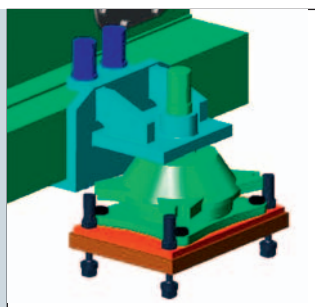
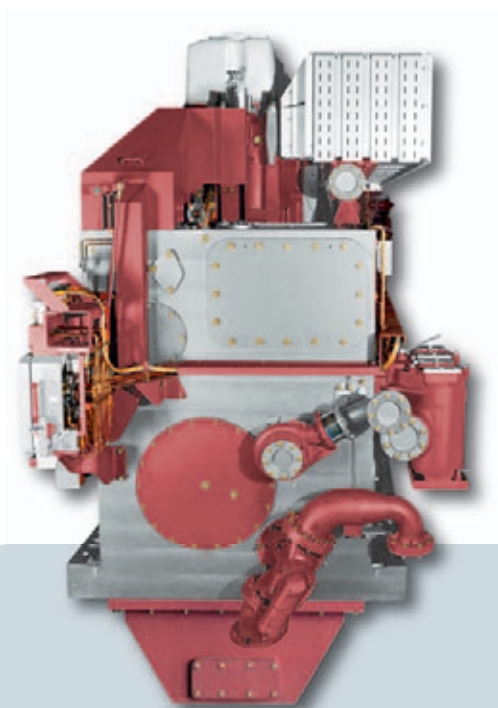

M 43 C – MaK Propulsion Package

Complete propulsion systems

The supply of complete propulsion systems is a market requirement which is becoming increasingly important. We have comprehensive experience gathered during the design and execution of many successful propulsion plant installations and resulting from our close cooperation with competent partners.

We offer

- System responsibility and supply from a single source
- Accurately matched interfaces
- Coordinated delivery data control

A complete propulsion system usually consists of:

- MaK main propulsion engine with flexible coupling
- Reduction gearbox with or without installed clutch and gearbox PTO* with shaft generator
- Propeller and shaft installation
- Including remote control and monitoring equipment

* Power Take Off

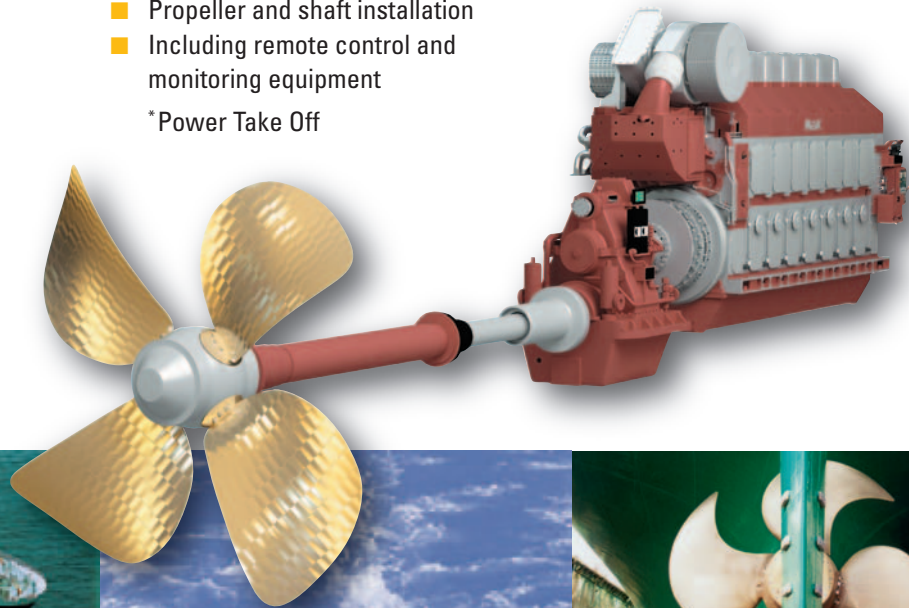

Engine			Gear				Shaft			Propeller		
Type	Rating kW	Speed rpm	A	B	C	D	E	F	G	H	Ø	Speed rpm
6 M 43 C	6000	500	7606	2878	1396	3560	2140	3400	3600	867	4500	160
7 M 43 C	7000	500	8492	2878	1396	3780	2140	4000	5000	978	4800	155
8 M 43 C	8000	500	9222	2878	1396	3780	2140	4000	5000	978	4950	155
9 M 43 C	9000	500	9952	2878	1396	3780	2920	4000	5000	978	5100	155

Subject to change without notice.

Examples of complete propulsion systems

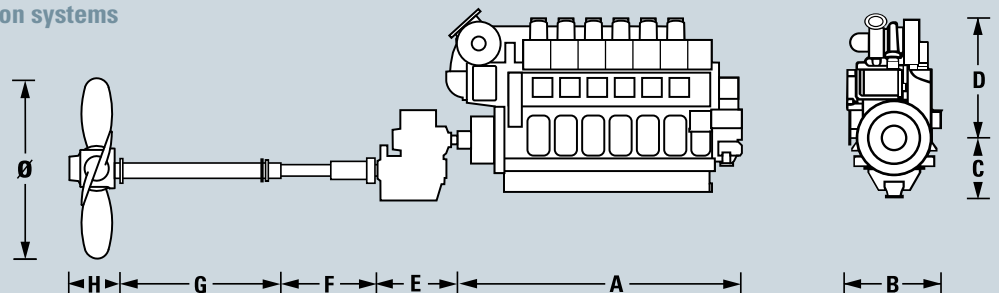

M 43 C – Emission Reduction Technology

The long-stroke concept for ecological operation

Environmental protection is also becoming increasingly important for seagoing shipping. Caterpillar Motoren recognized this trend in good time and, with the design and development of the modern long-stroke engine concept, created the conditions for engine operation at reduced emission levels. The NO_x emissions of the M 43 C engine lies well below the International Maritime Organisation's limiting curve.

The long-stroke concept for engine operation at reduced emission levels

The following features characterise the concept which ensures, in addition to smooth running, maximum operational reliability and also permits operation on heavy fuel oil up to 700 cSt/50°C.

- Long piston stroke
- Large stroke/bore ratio
- Intensive injection
- Shaped injection curve
- Optimised control times
- High ignition pressure

For MDO operation the engine is also available with less NO_x emission: Det Norske Veritas DNV "Clean Design" and Federal Ministry of Environment "Blue Angel".

A further step to reduce soot and emissions is the introduction of **Cat® Common Rail**, where the injection pressure is independent from load and speed. Utilizing injection maps the injection characteristics are optimized for every engine operating point. As a result, NO_x and soot emissions are reduced with the amount of reduction dependent on the actual engine operating condition.

For areas that are especially emissions-sensitive, soot emissions at low engine load remain well below the visibility limit. Furthermore, during normal load operation NO_x emissions can be reduced without influencing fuel consumption. In general, the Cat Common Rail fuel system enables vessel operation without visible soot throughout the whole operating range.

Key criteria are:

- Compliance with current and future required emission limits for the respective power ranges
- Customer expectations in terms of engine performance, maintenance practices, fuel quality and mode of operation

By adopting well proven elements of this technology for medium-speed engines, it is our goal to meet and exceed customer expectations by maximizing product value through:

- Superior reliability in heavy fuel operation
- Best fuel efficiency in its class
- Lowest engine emissions without additional equipment

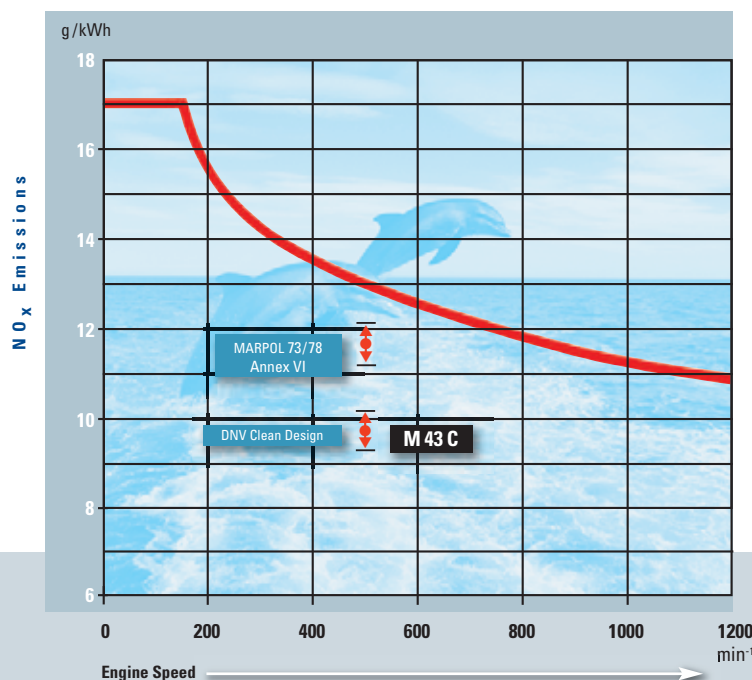

M 43 C – Technical Data

PROPULSION

Type	Output range		Speed	Mean eff. pressure	Mean piston speed	Bore	Stroke	Spec. fuel consumption	
								100%	85%
	kW	mhp	rpm	bar	m/s	mm	mm	g/kWh	g/kWh
6 M 43 C	6000	8160	500	27.1	10.2	430	610	176	175
	6000	8160	514	26.4	10.5	430	610	176	175
7 M 43 C	7000	9520	500	27.1	10.2	430	610	176	175
	7000	9520	514	26.4	10.5	430	610	176	175
8 M 43 C	8000	10880	500	27.1	10.2	430	610	176	175
	8000	10880	514	26.4	10.5	430	610	176	175
9 M 43 C	9000	12240	500	27.1	10.2	430	610	176	175
	9000	12240	514	26.4	10.5	430	610	176	175

Specific lubricating oil consumption 0.6 g/kWh, ± 0.3 g/kWh
LCV = 42700 kJ/kg, without engine-driven pumps, tolerance 5%

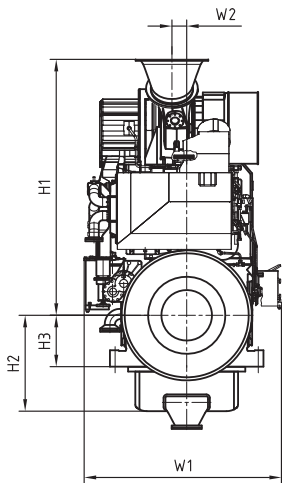
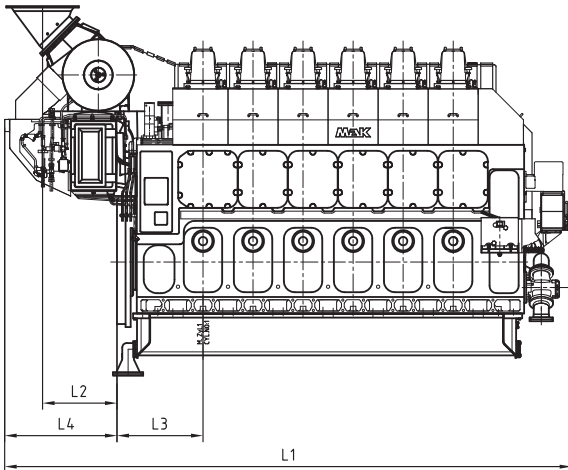

GENERATOR SETS

Type	Engine rating	Generator rating 50 Hz		Generator rating 60 Hz		Mean eff. pressure	Mean piston speed	Spec. fuel consumption	
		Speed: 514 rpm		Speed: 500 rpm				100%	85%
	kW	kWe	kVA	kWe	kVA	bar	m/s	g/kWh	g/kWh
6 M 43 C	6000			5760	7200	27.1	10.2	176	175
	6000	5760	7200			26.4	10.5	176	175
7 M 43 C	7000			6720	8400	27.1	10.2	176	175
	7000	6720	8400			26.4	10.5	176	175
8 M 43 C	8000			7680	9600	27.1	10.2	176	175
	8000	7680	9600			26.4	10.5	176	175
9 M 43 C	9000			8640	10800	27.1	10.2	176	175
	9000	8640	10800			26.4	10.5	176	175

Bore: 430 mm

Stroke: 610 mm

Specific lubricating oil consumption 0.6 g/kWh, ± 0.3 g/kWh
LCV = 42700 kJ/kg, without engine-driven pumps, tolerance 5%
Generator efficiency: 0.96, cos φ: 0.8

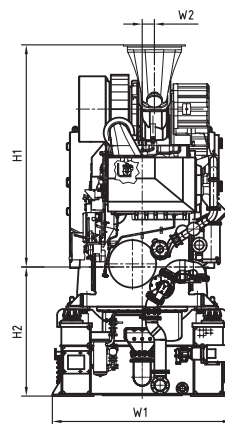
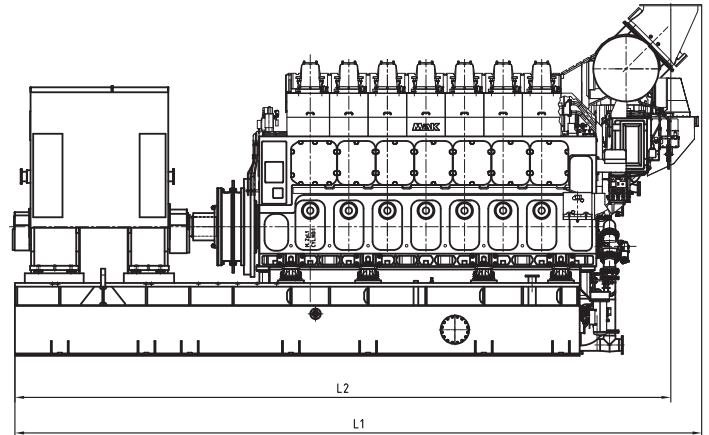

Propulsion Engine Dimensions (mm) and Weights (t)

Type	L1	L2	L3	L4	H1	H2	H3	W1	W2	t
6 M 43 C	8271	1086	1255	1638	3734	1399	750	2878	215	94.0
7 M 43 C	9068	1119	1255	1704	4105	1399	750	2878	232	107.0
8 M 43 C	9798	1119	1255	1704	4105	1399	750	2878	232	114.0
9 M 43 C	10528	1119	1255	1704	4105	1399	750	2878	232	127.0

Generator Dimensions (mm) and Weights (t)

Type	L1*	L2	H1	H2	W1	W2	t*
6 M 43 C	12202	11651	3834	2444	3400	215	178
7 M 43 C	12999	12414	4205	2444	3400	232	195
8 M 43 C	13729	13144	4205	2444	3400	232	210
9 M 43 C	14459	13874	4205	2444	3400	232	240

*Dependent on generator make/type.

Cat Financial – World-Class Financing Solutions

You specify Cat or MaK power solutions, because you believe in the power of Caterpillar engines to keep you and your vessel safely on course. Cat Financial has the same commitment to your success – whether you need construction, term or repower financing.

We know how to support customers in one country, construction in a second country and registration in a third. We understand the marine industry – we've been lending to marine customers for more than 20 years. And, as it has been since 1986, our service commitment is powered by Caterpillar and Cat and MaK dealers everywhere.

Global Coverage

Whether you're a German operator building at a Chinese shipyard or a U.S. citizen building a yacht in Italy, Cat Financial can help. Our customers do business around the world, and we support them wherever they go.

Our service commitment extends to all marine sectors. From production and custom yachts to workboats and tankers – we have you covered.

Local Presence

Need a local expert? We know local markets and how to navigate the legal and regulatory environments. Cat Financial has offices in the Americas, Europe and Asia, and financing representatives all over the world. Put our knowledge to work to power the deal.

Get your project moving anywhere in the world with Cat Financial – backed by the power of Caterpillar and our unmatched dealer network.

Visit us online at MARINE.CAT.COM/finance



Integrated Solutions – Product Support Portfolio

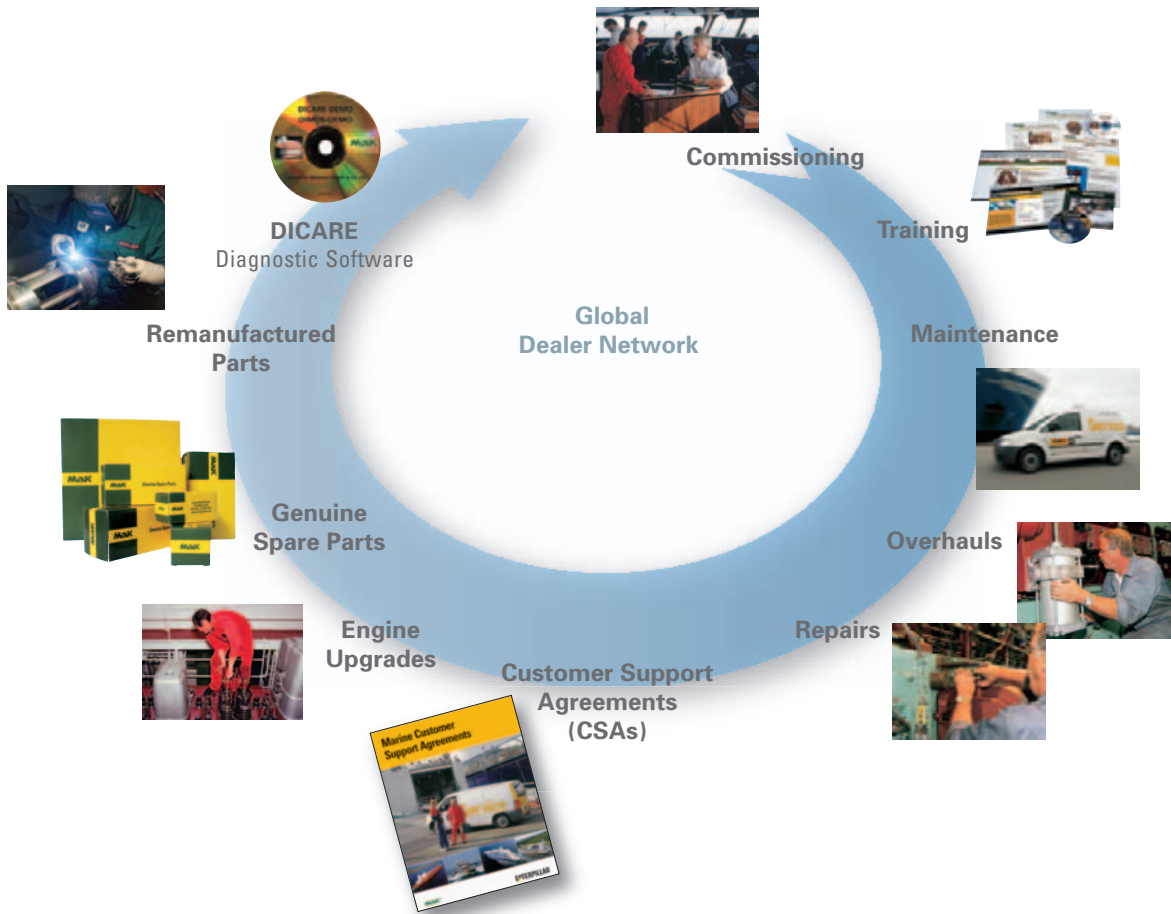

Providing integrated solutions for your power system means much more than just supplying your engines. Beyond complete auxiliary and propulsion power systems, we offer a broad portfolio of customer support solutions and financing options. Our global dealer network takes care of you wherever you are – worldwide. Localized dealers offer on-site technical expertise through marine specialists and an extensive inventory of all the spare parts you might need.

To find your nearest dealer, simply go to:
MARINE.CAT.COM



One Strong Line of World-Class Diesel Engines

Perfect Solutions for Main Propulsion and On-Board Power Supply

The Program: Quality is our Motto

For more than 80 years we have developed, built, supplied and serviced diesel engines – worldwide. Today Caterpillar Marine with its brands Cat and MaK offer high-speed and medium-speed engines with power ratings from 11 kW to 18,000 kW. Many different engine families are available to meet your specific application needs.

Cat and MaK diesel engines are distinguished by high reliability, extremely low operational costs, simple installation and maintenance and compliance with IMO environmental regulations.

The application of engines in main and auxiliary marine power systems varies greatly and extends from high-speed boats and yachts, through tugs, trawlers and offshore vessels to freighters, ferries and cruise liners.

Caterpillar Marine Power Systems

Sales and Service Organization

Caterpillar has combined the sales and service activities and responsibility of their Cat and MaK brand marine engine business into Caterpillar Marine Power Systems with headquarters in Hamburg/Germany.



In setting-up this worldwide structure, we have concentrated on integrating the Cat and MaK brand groups into a single, united marine team, which utilises the particular expertise of each group.

Commercial marine engine business is split into three geographic regions,

- Europe, Africa, Middle East
- Americas ■ Asia-Pacific,

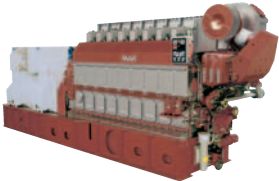

<p>● C1.5 3 cylinder 10–14.5 kW_e 10–18.0 kVA</p>	<p>● C2.2 4 cylinder 16–30 kW_e 16–37.5 kVA</p>	<p>● C4.4 4 cylinder 36–99 kW_e 45–123 kVA</p>	<p>● C6.6 ACERT 6 cylinder 93–170 kW_e 116–212 kVA</p>	<p>● C9 6 cylinder 142–250 kW_e 178–313 kVA</p>	<p>● C18 ACERT 6 cylinder 275–550 kW_e 344–688 kVA</p>	<p>● C32 ACERT 12 cylinder 715–940 kW_e 675–1,138 kVA</p>	<p>● 3500 8, 12, 16 cylinder 590–1,825 kW_e 738–2,281 kVA</p>	<p>● C280 6, 8, 12, 16 cylinder 1,650–5,200 kW_e 2,063–6,500 kVA</p>
--	--	---	---	--	---	--	--	---

 <p>● M 20 C 6, 8, 9 cylinder 979–1,641 kW_e 1,224–2,052 kVA</p>	 <p>● M 25 C 6, 8, 9 cylinder 1,920–2,880 kW_e 2,400–3,600 kVA</p>	 <p>● M 32 C 6, 8, 9 cylinder 2,765–4,320 kW_e 3,456–5,400 kVA</p>	 <p>● VM 32 C 12, 16 cylinder 5,760–8,448 kW_e 7,200–10,560 kVA</p>
--	--	--	---

GENSETS



<p>● 3056 6 cylinder 93–153 kW</p>	<p>● C7 6 cylinder 187–276 kW</p>	<p>● C7 ACERT 6 cylinder 339 kW</p>	<p>● C9 ACERT 6 cylinder 375–423 kW</p>	<p>● C12 6 cylinder 254–448 kW</p>	<p>● C12 ACERT 6 cylinder 492–526 kW</p>	<p>● C18 ACERT 6 cylinder 339–847 kW</p>
---	--	--	--	---	---	---

Propulsion Engines



<p>● M 20 C 6, 8, 9 cylinder 1,020–1,710 kW</p>	<p>● M 25 C 6, 8, 9 cylinder 1,900–3,000 kW</p>	<p>● M 32 C 6, 8, 9 cylinder 2,880–4,500 kW</p>	<p>● VM 32 C 12, 16 cylinder 6,000–8,000 kW</p>	<p>● M 43 C 6, 7, 8, 9 cylinder 6,000–9,000 kW</p>
--	--	--	--	---

MAIN PROPULSION

Caterpillar Marine Power Systems Production Facilities

which manage all sales and product support activities. They have direct responsibility for achieving the ambitious growth targets set for the Cat and MaK brands and for providing our customers and dealers with complete marine solutions.

Caterpillar's global dealer network provides a key competitive edge – customers deal with people they know and trust.

Cat dealers strive to form a strong working relationship with their customers, offering comprehensive and competent advice from project support to repair work.

Some of the most advanced manufacturing concepts are used at Caterpillar locations throughout the world to produce engines in which reliability, economy and performance are second-to-none.

From the production of core components to the assembly of complete engines, quality is always the top priority.

Comprehensive, recognized analysis systems, test procedures and measuring methods ensure that quality requirements

are met throughout all the individual manufacturing phases. All of our production facilities are certified under 1:2000 ISO 9001 EN, the international benchmark that is helping to set new quality standards worldwide.

In addition to product quality, our customers expect comprehensive service which includes the supply of spare parts throughout the life of the engine.

Onboard Power Supply

- High-Speed Engines
- Medium-Speed Engines

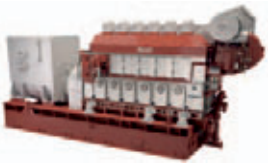

● **M 43 C**
6, 7, 8, 9 cylinder
5,760–8,640 kW
7,200–10,800 kVA

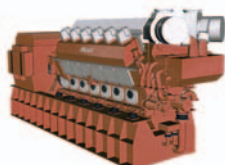

● **VM 43 C**
12, 16 cylinder
11,520–15,360 kW
14,400–19,200 kVA



● **M 46 DF**
6, 7, 8, 9 cylinder
5,148–7,776 kW
6,480–9,720 kVA

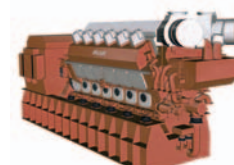

● **VM 46 DF**
12, 16, 20 cylinder
10,368–17,280 kW
12,960–21,600 kVA



● **C32 ACERT**
12 cylinder
492–1,417 kW



● **3500**
8, 12, 16 cylinder
526–2,525 kW



● **C175**
16 cylinder
2,001–2,168 kW



● **C280**
6, 8, 12, 16 cylinder
1,730–5,650 kW

- High-Speed Engines
- Medium-Speed Engines



● **M 46 DF**
6, 7, 8, 9 cylinder
5,400–8,100 kW

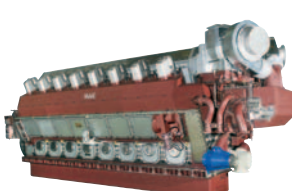

● **VM 43 C**
12, 16 cylinder
12,000–16,000 kW

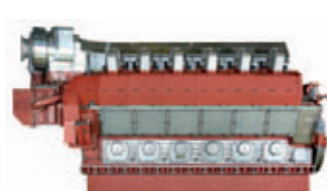

● **VM 46 DF**
12, 16, 20 cylinder
10,800–18,000 kW

Caterpillar Marine Power Systems

Headquarters

Caterpillar Marine Power Systems
A Division of
Caterpillar Motoren GmbH & Co.KG
Neumühlen 9
22763 Hamburg/Germany

Phone: +49 40 2380-3000
Telefax: +49 40 2380-3535

Europe, Africa, Middle East

Caterpillar Marine Power Systems
A Division of
Caterpillar Motoren GmbH & Co.KG
Neumühlen 9
22763 Hamburg/Germany

Phone: +49 40 2380-3000
Telefax: +49 40 2380-3535

Americas

MaK Americas Inc.
3450 Executive Way
Miramar Park of Commerce
Miramar, FL 33025/USA

Phone: +1 954 885 3200
Telefax: +1 954 885 3131

Asia Pacific

Caterpillar Marine Trading (Shanghai) Co., Ltd.
25/F, Caterpillar Marine Center
1319, Yan'an West Road
200050 Shanghai/P. R. China

Phone: +86 21 6226 2200
Telefax: +86 21 6226 4500

Caterpillar Marine Asia Pacific Pte Ltd
No. 5 Tukang
Innovation Grove
Singapore 618304
Republic of Singapore

Phone: +65 68287-600
Telefax: +65 68287-625

For more information please visit our website:
MARINE.CAT.COM

Subject to change without notice.
Leaflet No. 243 · 08.12 · e · L+S · VM3

© 2012 Caterpillar All Rights Reserved. Printed in Germany. CAT, CATERPILLAR, their respective logos, ACERT, ADEM, „Caterpillar Yellow“ and the POWER EDGE trade dress, as well as corporate identity used herein, are trademarks of Caterpillar and may not be used without permission.



Caterpillar Marine Power Systems is committed to sustainability. This document is printed on PEFC certificated paper.

MaK