

PM620 AND PM622

Cold Planers



Cat® C18 Engine

Gross Power (SAE J1995)	470 kW	630 hp
Gross Power (ISO 14396)	462.5 kW	620.2 hp

Operating Weight

PM620	33 330 kg	73,260 lb
PM622	33 900 kg	74,580 lb

Cutting Dimensions

Width - PM620	2010 mm	79 in
Width - PM622	2235 mm	88 in
Maximum Cutting Depth	330 mm	13 in



CONTENTS

Introduction	2, 3
Machine Feature Overview	4, 5
Powertrain, Undercarriage	6, 7
Operating Environment	8, 9
Cutting System	10, 11
Cat Grade Control Option	12, 13
Material Collection System	14, 15
Optional Equipment	16, 17
Service and Reliability	18, 19
Cutting Bits	20
Cat Diamond Bits	21
Specifications	22, 23



THE HALF-LANE MILLING MACHINES YOU HAVE BEEN WAITING FOR

Cat® PM620 and PM622 cold planers are the product of years of study, tinkering, rethinking. Every system and component has been examined, refined, optimized. The result is an advanced, world-class cold planer.

The payoff for contractors is immediate: lowered operating costs and increased productivity, paired with Cat reliability and the legendary dealer support you expect from Caterpillar.

The PM620 and PM622 are well equipped to deliver precision and efficient high production. Many options are available to enhance machine versatility and customize operations to suit the application, from milling highways to urban streets. Whether you are texturing the surface or milling an airport runway, there is a configuration that will meet your requirements and expectations.

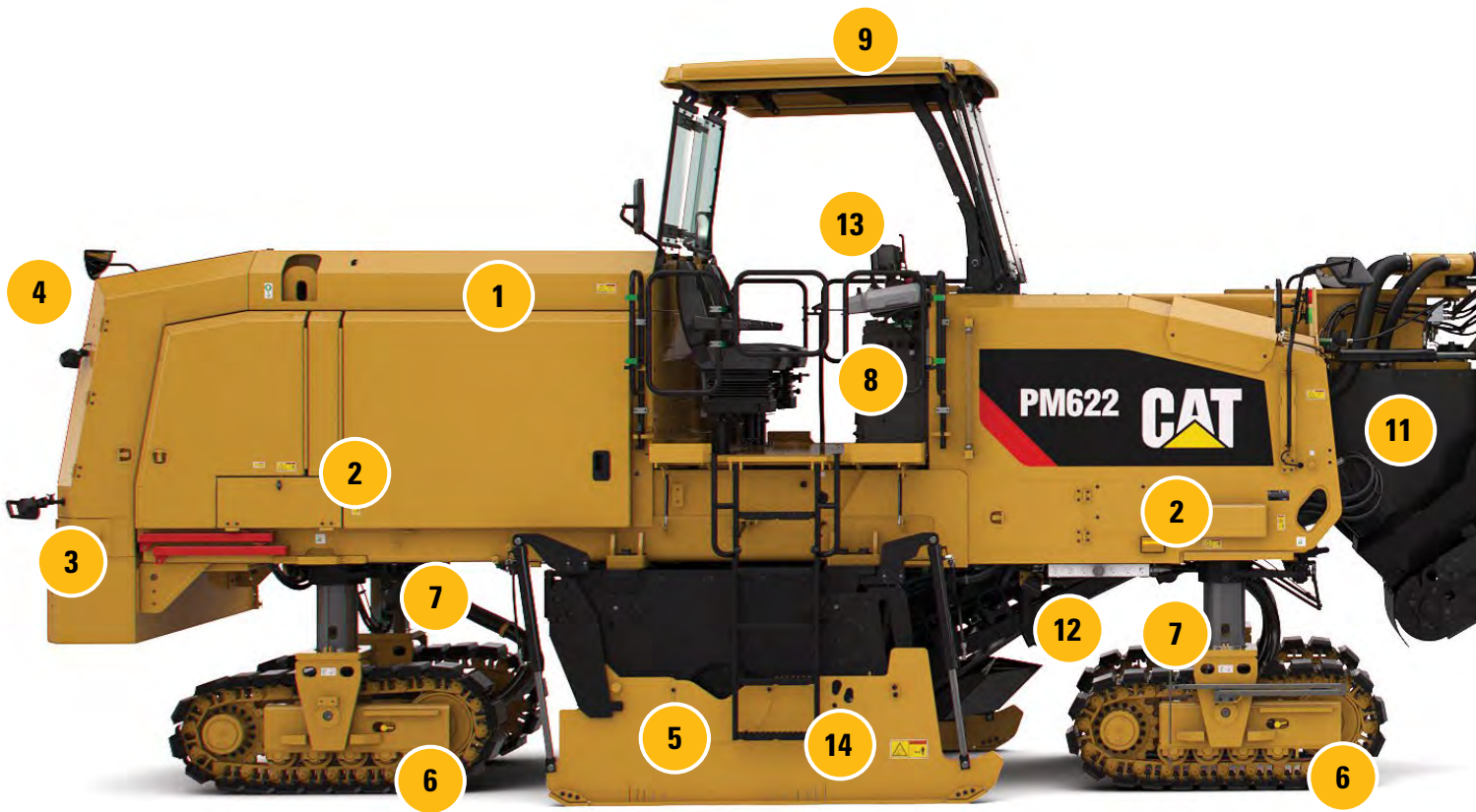

WIDE AND WIDER

CHOOSE THE WIDTH THAT SUITS YOU.



1. Cat C18 Engine
2. Ground Control Console
3. Rear Water Fill Nozzle
4. Remote Camera (option)
5. Hydraulic Side Plates with Position Sensors
6. Crawler Tracks with Bolt-on Pads
7. Advanced Steering
8. Dual Operating Consoles
9. Power Canopy (option, shown with optional windscreens)
10. Dust Abatement System (option)
11. High Pressure Water Spray Hose (option)
12. Water Spray Control and Clean out Manifold
13. LCD Touchscreen Display
14. Cat Diamond Bits (option)
15. Cat Grade Control (option)



RUGGED POWERTRAIN

SIMPLE DESIGN DELIVERS AMPLE POWER TO GROUND.

C18 ENGINE

- Meets regional emission standards as required:
U.S. EPA Tier 4 Final / EU Stage V
or Tier 3 / Stage IIIA / China Stage III equivalent
- Provides ample power
- Automatic idle control function and multiple rotor speeds optimizes output to the demand on the engine, keeping operation smooth and efficient
- High capacity cooling system keeps engine at ideal temperature for optimal fuel efficiency and lower emissions
- Proven core engine design ensures reliability and quiet operation
- Engine is iso-mounted to reduce noise and vibration

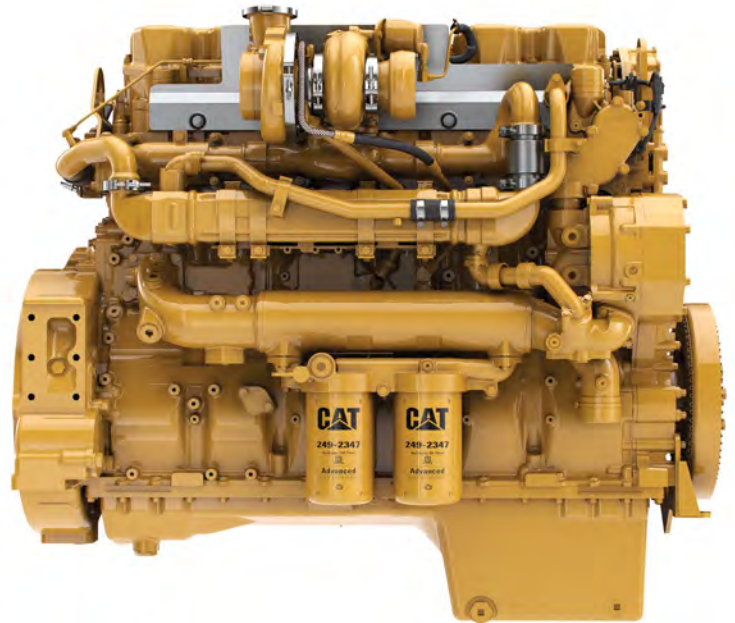

PROPEL SYSTEM

- Robust propel system features two propel pumps and two propel circuits, diagonally opposed; each circuit drives the propel motors for two crawler tracks
- Cross-flow traction control supplies dedicated hydraulic flow diagonally across machine to the tracks that grip
- Automatic Load Control senses load changes on the rotor system load and adjusts propel speed to prevent stalls and optimize production



STABLE PLATFORM

- Four leg posts with position sensors independently adjust and provide powered vertical movement to maintain desired height
- Ride-control feature ensures smooth travel
- Optional Cat Grade Control is integrated with the machine and works seamlessly to provide maximum cutting precision; system can be enhanced to full 3D milling capability

WORRY-FREE TRACKS

- Four crawler tracks based on proven Cat track design and components
- Tracks automatically adjust to provide ideal tension
- Track pads are easily replaceable with bolt-on design

EXCELLENT MANEUVERABILITY

- Four steering modes: front steer, rear steer, crab steer, coordinated steer
- Advanced steering function adjusts track alignment to provide precise steering geometry and reduce pad wear
- Minimum left cutting radius: 2 m (6.56 ft)
- Minimum right cutting radius:
 - PM620- 2 m (6.56 ft)
 - PM622- 1.8 m (5.91 ft)



The four post design offers excellent maneuverability and dependable operation to maximize versatility and production.



COMFORT AND CONTROL

OPERATE WITH CONFIDENCE.

OPERATING ENVIRONMENT

- Height-adjustable dual operating console is intuitive and comfortable
- Optional power canopy can deploy or stow during machine operation; optional windscreen panels available
- Touchscreen LCD display provides gauge cluster, operating information, remote camera feed, machine control and diagnostics; optional second and third display available to provide additional gauge or machine operation/control information
- Optional suspension seats reposition for optimal visibility and comfort
- Lockable storage provides secure area to stow personal items
- 12-volt power receptacle

ERGONOMIC CONTROLS

- Controls comfortably positioned for easy use
- Large, backlit keypads are visible in all light conditions
- Durable design tested to 1 million cycles
- Lockable covers provide protection from vandalism

EQUIPPED FOR 24/7 OPERATION

- Working areas and perimeter well lit with standard halogen lights
- Displays and controls easy to see
- Additional LED light options
- Available balloon lighting options



FRONT



REAR

Dual controls and large LCD screens keep the operator informed and in control.



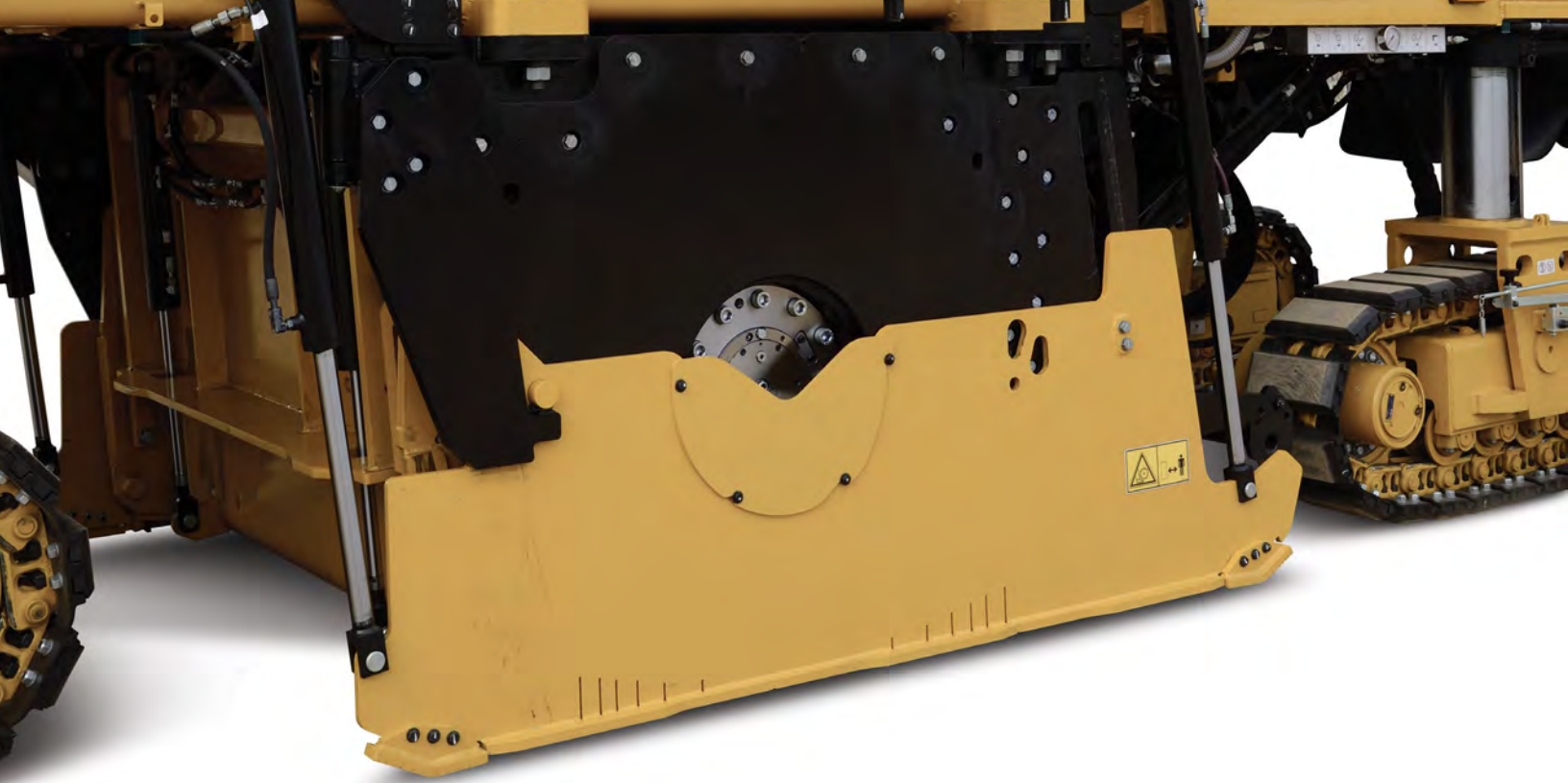

CUTTING SYSTEM

EFFICIENT AND DEPENDABLE, AS IT SHOULD BE.

ROBUST ROTOR CHAMBER

- Chamber optimizes material flow to promote thorough clean-out
- Thicker steel in areas exposed to high abrasion enhances durability
- Side plates are hydraulically adjustable with position-sensing cylinders, can be used as an averaging ski
- Hydraulically adjustable moldboard applies optimal down-pressure to keep material contained for clean out and minimize required sweeping

ANTI-SLAB DEVICE

- Helps to optimize sizing and gradation
- Protects collecting conveyor
- Prevents blockage in the discharge opening

THE VERSATILITY YOU NEED

- Two available cutting widths;
- Cutting depth to 330 mm (13 in)
- Enhanced clearance for flush cutting
- Three rotor speeds, electronically selectable during operation
- High production and fine milling drums available
- Optional Cat Grade Control keeps machine on target



ADVANCED AUTOMATED FEATURES

- Automatic Load Control senses load changes on the rotor and adjusts propel speed to prevent stalls and optimize production
- Automatic plunge-cut feature ensures precise, repeatable starting cuts and reduces wear on machine (requires Cat Grade Control option)
- Ramp-in, Ramp-out cutting capability (requires Cat Grade Control option)
- Jump hold feature assists to clear obstacles

ROTOR DRIVE SYSTEM

- Driven by two 5-rib high-tensile belts
- Automatic belt tensioning to reduce slippage
- Heavy-duty dry clutch

HIGH PRODUCTION ROTORS

- 2.0 m (79 in) or 2.2 m (88 in) cutting widths
- Cutting bits held in exclusive conical quick-release tool holders and arranged in a triple-wrap flight pattern
- Large, replaceable carbide-faced loading paddles effectively move milled material onto collecting conveyor
- Standard 15 mm (5/8 in) tool tip spacing is optimal for high production and reduced wear
- Triple tree tool arrangement on rotor ends reduces wear on rotor when maneuvering in the cut
- Premium carbide bits available
- Optional Cat Diamond Bits provide cutting life up to 80 times longer than conventional carbide bits, decreasing overall fuel consumption and reducing machine wear



ABOVE: Exclusive 3-piece conical tool holders
BELOW: Reversible, replaceable carbide-faced loading paddles

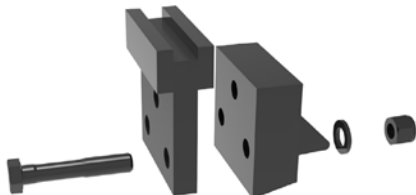



CAT GRADE CONTROL

EASY TO USE; HIGH PRECISION.



INTEGRATED DESIGN

- System communicates directly with position-sensing hydraulic cylinders, slope sensors and processors to ensure optimal precision

CONTROL BOXES

- LCD color touchscreen display with soft keys is durable and visible in all light conditions
- Intuitive interface is easy to understand and use
- Supports multiple languages
- Control boxes and sensors can be repositioned without reconfiguring settings
- Full control over grade and slope can be attained from any control box



REFERENCE VERSATILITY

1. Sonic Mounting Point
2. Control Box Mounting Point
3. Position-sensing Independently Controlled Side Plates
4. Optional Position-sensing Hydraulically Controlled Inboard Ski

SYSTEM VERSATILITY

- System can utilize various references including sonics, contact sensors, position sensing hydraulic cylinders, wire rope sensors
- Can be enhanced for full 3D operation
- Sensors can be positioned in multiple inboard or external locations around the machine

SONIC SENSORS

- Sensor units feature five ceramic transducers
- System discards the highest and lowest readings and averages remaining three for a true average
- Each unit equipped with temperature sensor that compensates for fluctuations due to temperature change
- Durable construction outlasts foil transducer design



Each sensor has five transducers; the high and low readings are discarded and the remaining three are averaged for a true average reading.

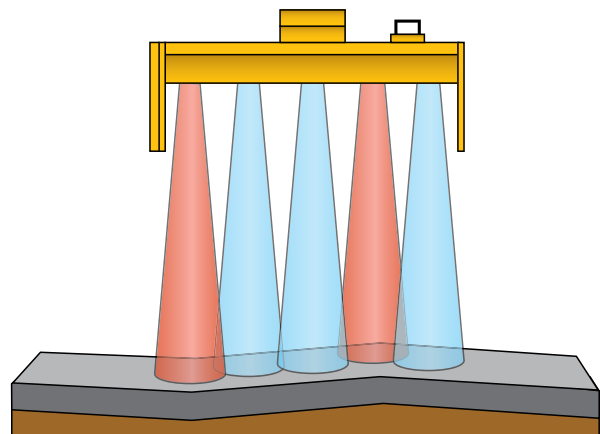

BLUE: Averaged readings
RED: Discarded readings



HIGH CAPACITY MATERIAL REMOVAL

EFFICIENT AND EFFECTIVE.

The high-capacity conveyors provide efficient removal of milled material and dust with outstanding discharge control.

COLLECTING CONVEYOR

- A wide opening and seamless 850 mm (33.5 in) wide belt efficiently clears rotor chamber
- Reversible for easy clean out
- Optional grease tensioner provides easy adjustment of belt alignment and tension.

WATER SPRAY SYSTEM

- Water spray system provides lubrication and cools bits while helping to control dust
- Spray system fed by 3500 L (884 gal) onboard tank; tank can be filled from top deck ports, rear fill valve, side fill valve or optional refill pump
- Optional additional water spray system provides maximum lubrication, cooling and dust suppression
- Onboard winterization system utilizes compressed air to purge water lines

OPTIONAL DUST ABATEMENT SYSTEM

- Vacuum system ports to collecting conveyor housing and transition between collecting and loading conveyor to remove airborne particles
- Augments dust suppression provided by water spray system
- Discharges collected dust into the loading conveyor to facilitate removal from working area around machine
- Maximizes dust removal capability when used with water spray system and optional additional water spray system



LOADING CONVEYOR

- Aluminum covers and vinyl side panels reduce spillage and help control dust
- Seamless 850 mm (33.5 in) wide belt provides heavy duty, high speed discharge
- Variable belt speed optimizes speed to material type and production rate
- Reversible for easy clean out
- "Boost" feature provides a temporary surge in belt speed to help precisely place material
- Loading conveyor folds to reduce length for transport
- Loading conveyor swings 60 degrees from center position to the left or right

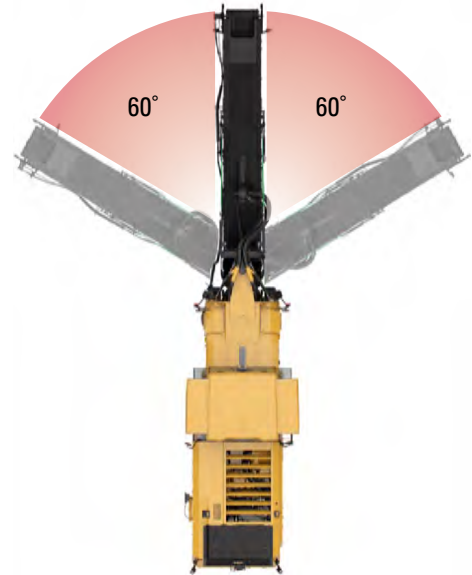

OPTIONAL EQUIPMENT

OPTIMIZE VERSATILITY, PRODUCTIVITY, COMFORT.

CAT GRADE AND SLOPE CONTROL

System is integrated with the machine for maximum precision

POWER SUN CANOPY

Deploys or stows hydraulically

WINDSCREENS FOR POWER SUN CANOPY

CAT DIAMOND BITS

Lasts up to 80 times longer than conventional carbide bits

ADDITIONAL LCD TOUCHSCREEN DISPLAY

For use to monitor machine functions

PRODUCT LINK, ADDITIONAL CONFIGURATIONS

Keep track of your machine health, location or fleet use

ADDITIONAL WATER SPRAY SYSTEM

Second system augments lubrication, bit cooling and dust suppression capabilities of the standard system

INBOARD AVERAGING SKI

Hydraulically controlled ski provides inboard reference for grade control system

ROTOR TURNING DEVICE

Assists with turning rotor during rotor service

DUST ABATEMENT SYSTEM

Vacuum system ports to the transition area between the rotor chamber and the collecting conveyor as well as the transition between the collecting conveyor and the loading conveyor; dust is removed and expelled within the loading conveyor, where it is discharged with the milled material

REMOTE CAMERA, LOADING CONVEYOR

Mounts to the discharge end of the loading conveyor; provides enhanced view of discharge loading

REMOTE CAMERA, REAR

Mounts to the rear of machine; provides enhanced view of area behind the machine

REMOTE CAMERA, MAGNETIC MOUNT

Mounts magnetically to various locations; up to two magnetic cameras can be used

SUSPENSION SEAT

Adjustable seats installed on operator's platform

BIT BUCKET TRAYS

Trays mount to rear crawlers and provide convenient storage for bit buckets

HIGH PRESSURE WASHDOWN SYSTEM

High pressure hose and spray wand connect to onboard water tank to deliver high pressure water spray for convenient clean up

WATER TANK TRANSFER PUMP

Water pump provides additional options to fill onboard water tank

FUEL TRANSFER PUMP

Fuel pump provides additional options to fill fuel tank

WARNING BEACON, FIXED

Amber warning beacon mounts to one of two fixed locations on loading conveyor or rear of machine

WARNING BEACON, MAGNETIC MOUNT

Amber warning beacon can be magnetically mounted in multiple locations on the machine

COMMISSIONING SUPPORT

Cat technician provides machine introduction and training to key personnel



1. Power Sun Canopy
2. Inboard Averaging Ski
3. Dust Abatement System
4. Remote Camera, Loading Conveyor

5. Remote Camera, Magnetic Mount
6. Bit Bucket Trays
7. High Pressure Washdown System
8. Water Tank Transfer Pump

EASY SERVICE

DESIGNED RIGHT IN.

Outstanding access to critical components and systems makes service and maintenance easier and faster. That keeps your machine where you need it: on the job.

LARGE ACCESS DOORS AND PANELS

- Designed to facilitate efficient service, reducing labor costs and service time
- Quick and easy maintenance
- Accessible pumps and components
- Power hood opens to allow walk-in access
- Visual indicators simplify routine service checks

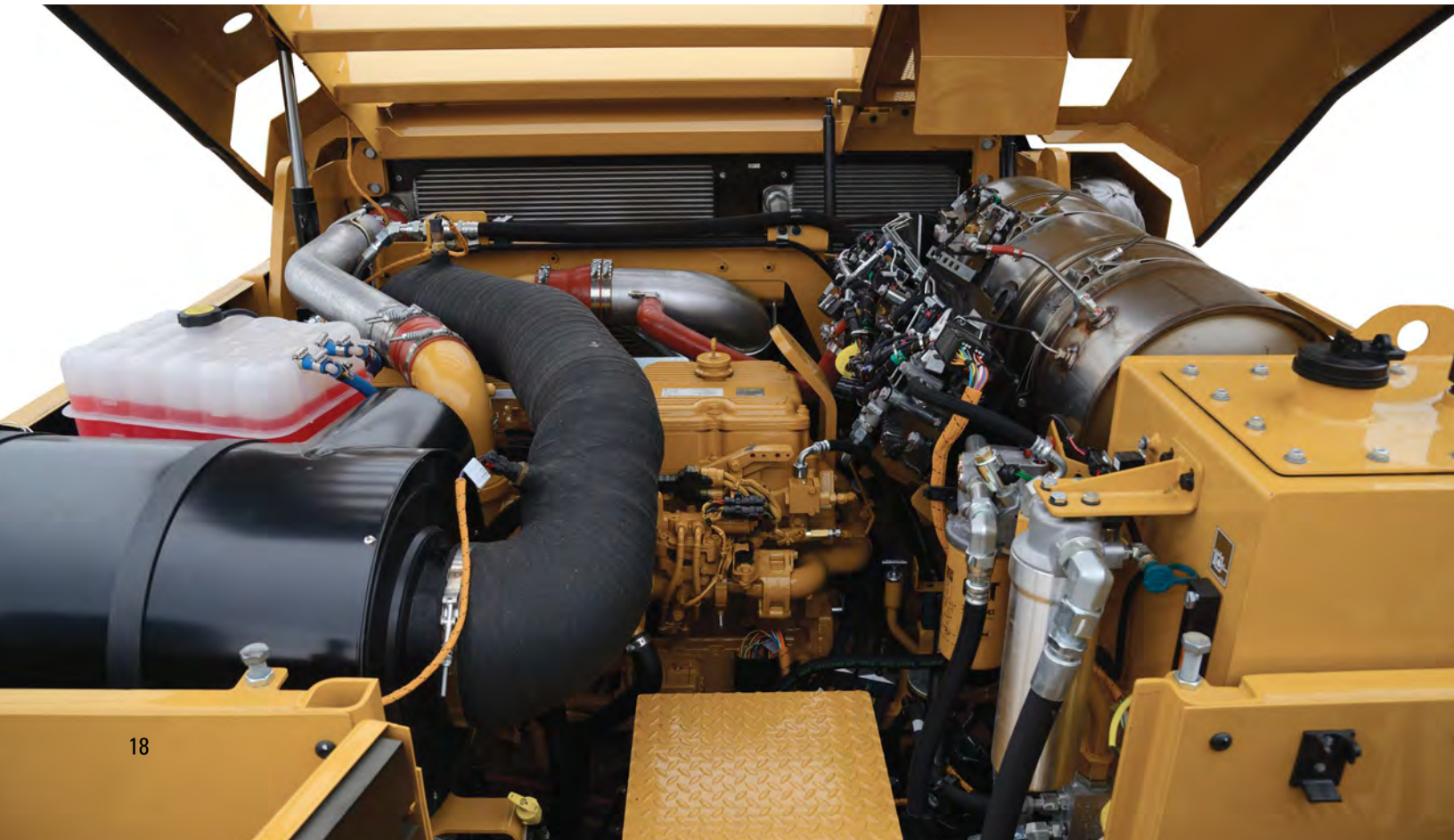
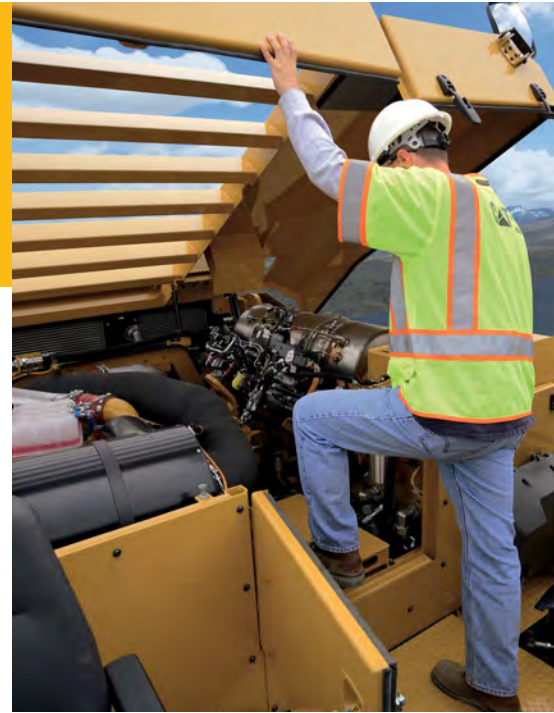

HYDRAULIC SYSTEM

- Manual overrides simplify troubleshooting by eliminating functioning systems
- Hydraulic hoses are cleanly routed and clamped for long-term reliability
- Exposed hoses are wrapped in nylon sleeves for protection against abrasion
- Pressure test ports and oil sampling ports simplify hydraulic system diagnosis

ELECTRICAL SYSTEM

- 24-volt system with 100 amp alternator
- Color-coded and numbered electrical wiring simplifies troubleshooting
- Harnesses are wrapped in abrasion-resistant nylon braid

ELECTRONIC CONTROL MODULES (ECM)

- Monitors machine systems to ensure proper function and precision
- Provides warning indications via LCD touchscreen display when machine performance is substandard
- Provides diagnostic information

TELEMATICS: PRODUCT LINK™

- Maximize up-time
- Automatic machine location
- Hour updates
- Diagnostic codes
- Schedule service at convenient times
- Optional configurations available

LONG SERVICE INTERVALS

- 500 hour engine oil service interval
- 3,000 hour hydraulic oil service interval without oil sampling; 6,000 hours with oil sampling

ACCESSORY DRIVE SYSTEM

- Provides full operational control of primary machine functions to enable assisted machine movement during maintenance or service
- Facilitates assisted relocation of machine from live construction area to service area during emergency situations



CUTTING BITS

OPTIMIZE PERFORMANCE, MAXIMIZE PRODUCTION.



PREMIUM CUTTING BITS

Your Cat Dealer can supply you with a wide assortment of cutting bits to match performance to your application. Offering superior holder protection and easy penetration, the right cutting bit can ensure peak machine performance, providing maximum production, greater fuel efficiency and less wear on your machine.

A wide range of styles, shapes and shank sizes to accommodate most rotors, engine powers, materials and applications.

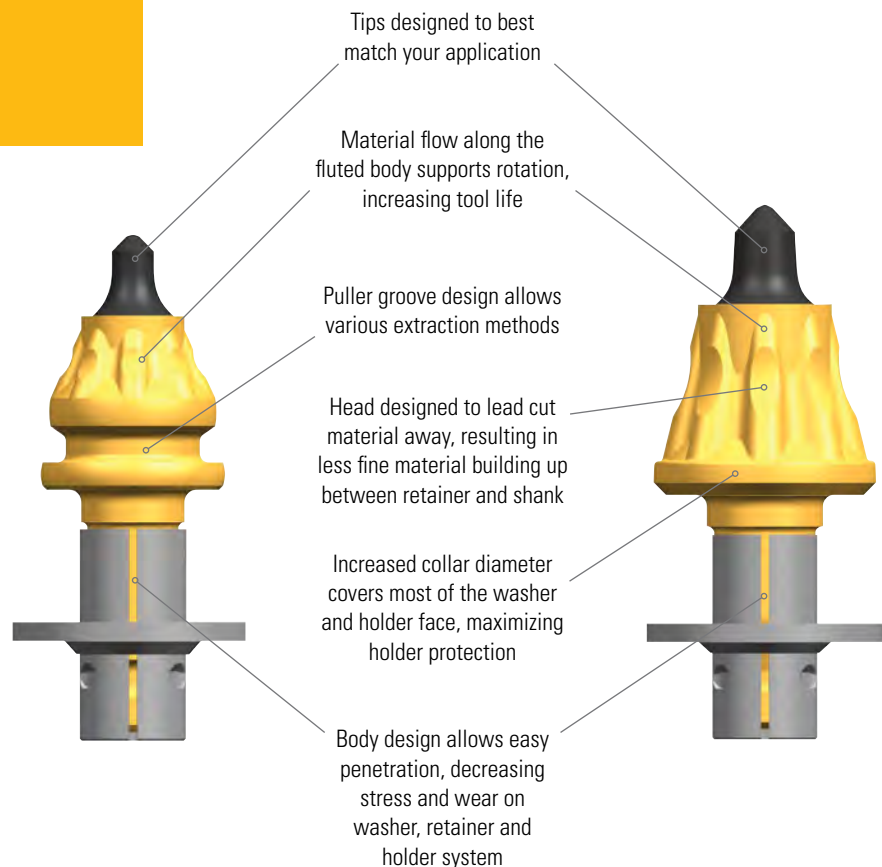

CAT DIAMOND BITS

STAY SHARP UP TO **80X** LONGER THAN CONVENTIONAL CARBIDE.

PROVEN BENEFITS

More efficiency, more productivity, lower fuel consumption and less wear on the machine. It all adds up to more profitability and growth for your company.

- Last up to 80x longer than carbide tips, keeping crews more productive, month after month
- Assure faster project completions
- Provide you with a significant bidding advantage
- Virtually eliminate labor costs for pick changes; eliminate unplanned, unproductive interruptions
- Deliver proven fuel savings per ton of production
- Enable faster milling speeds and increased productivity
- Eliminate costly bit inventory, and the handling that goes with it
- Require no rotation, crucial because half of carbide failures result when tools fail to turn
- Create less vibration, increasing the life of planetaries, drive shafts, stub shafts, bearings and other parts and components
- Increase track-pad life because the machine does not work as hard
- Deliver a dramatically improved return on your mill investment through increased engagement
- Extend life of moldboards through a consistent pattern; protect welded-on base blocks—and ultimately the drum

Average life and exact tonnage is impacted by local aggregate and operating technique. Diamond Asphalt Bits last up to 45x the life of standard carbide bits and Diamond Extended Life Bits last up to 80x the life of standard carbide bits.



SPECIFICATIONS

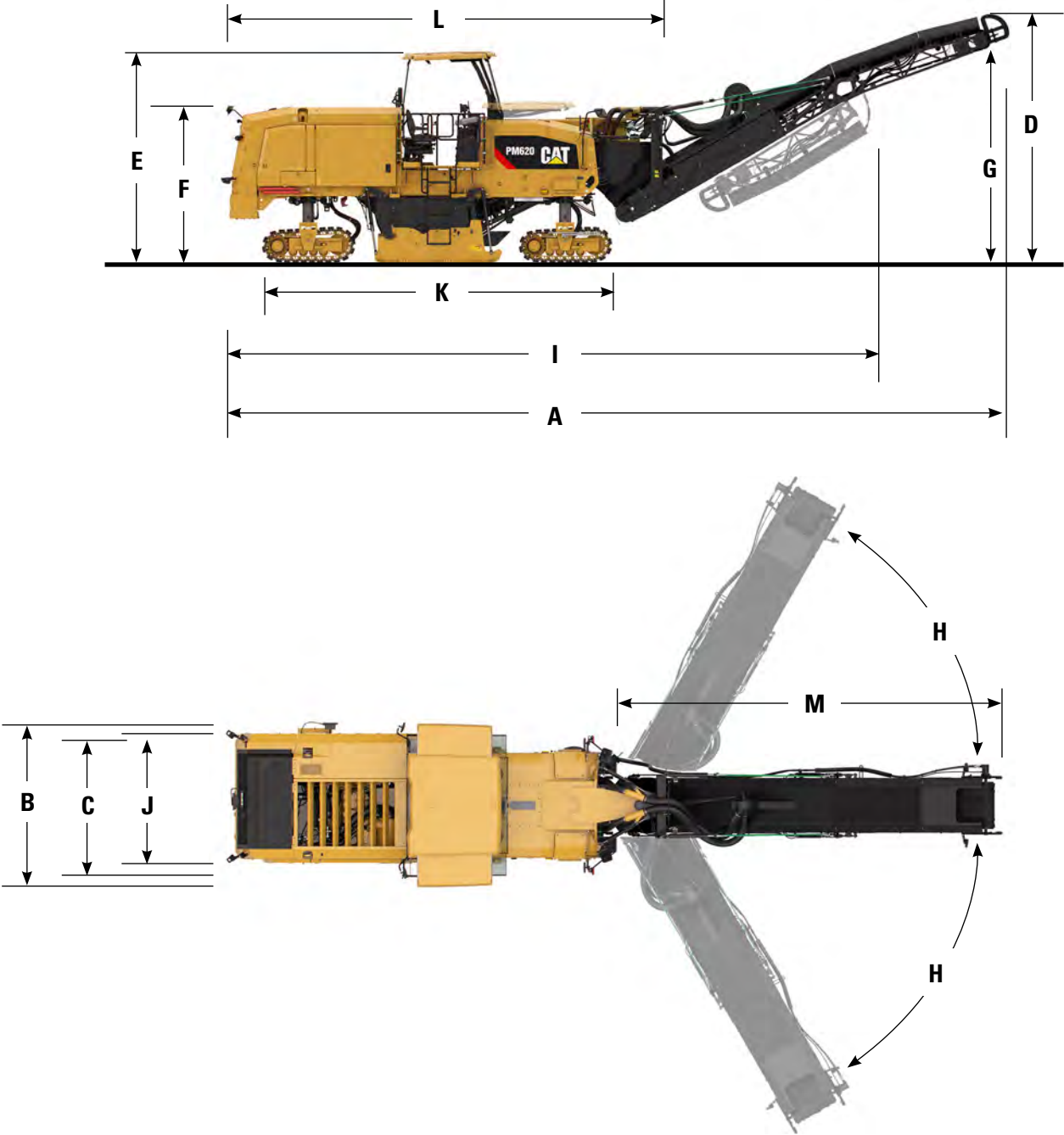

SPECIFICATIONS

Operating Dimensions

A Overall length, conveyor up	14.52 m	47.62 ft
B Maximum machine width	2.79 m	9.15 ft
C Cutting width - PM620	2010 mm	79.1 in
Cutting width - PM622	2235 mm	88 in
D Maximum height, raised conveyor	5.23 m	17.17 ft
E Height to optional canopy	4.05 m	13.29 ft
F Height, no canopy (canopy down)	3.00 m	9.84 ft
G Maximum truck clearance	4.86 m	15.95 ft
H Conveyor swing	± 60° from center	

Shipping Dimensions

I Transport length	12.43 m	40.79 ft
J Transport width - PM620	2.50 m	8.2 ft
Transport width - PM622	2.70 m	8.83 ft
K Length, track to track	6.69 m	21.95 ft
L Length of base machine	8.33 m	27.33 ft
M Conveyor length	8.38 m	27.48 ft
F Transport height	3.00 m	9.84 ft

Weight

PM620

Operating weight	33 330 kg	73,260 lb
Transport weight	29 400 kg	64,680 lb

PM622

Operating weight	33 900 kg	74,580 lb
Transport weight	30 000 kg	66,140 lb

Weights shown are approximate and include:

- Operating weights include coolants, lubricants, full fuel tank, full water tank and 75 kg (165 lb) operator.
- Transport weights include coolants, lubricants, 50% full fuel tank and empty water tank.

Powertrain

Cat C18 Engine		
Gross power - SAE J1995	470 kW	630 hp
Gross power - ISO 14396	462.5 kW	620.2 hp
Global emissions	US EPA Tier 4 Final / EU Stage V or Tier 3 / Stage IIIA / China Stage III equivalent	
Operating speed	100 m/min	328 ft/min
Maximum travel speed	5.9 km/h	3.7 mph

Cutting System

PM620 Milling Width	2010 mm	79.1 in
Number of Bits	170	
PM622 Milling Width	2235 mm	88 in
Number of Bits	185	
Maximum Cutting Depth	330 mm	13 in
Rotor Speeds	100 / 109 / 118 rpm	

Service Refill Capacities

Fuel Tank	1108 L	288.1 gal
DEF Tank*	47 L	12.2 gal
Cooling System	85 L	22.1 gal
Engine Oil	65 L	113 gal
Hydraulic Oil	113 L	29.4 gal
Water Tank	3400 L	898 gal

Optional Equipment

Power Canopy
Windscreens for Power Canopy
Inboard Averaging Ski
CE Certificate
Additional Water Spray System
Water Tank Transfer Pump
Fuel Transfer Pump
Dust Abatement System
Cat Grade Control
Remote Camera (Front, Rear, or Magnet Mount)
Product Link (optional configuration)
Air-ride Operator's Seats
Drum Rotating Device
Cat Diamond Bits
Bit Bucket Trays
Machine Commissioning Support

* Equipped on machines sold in Canada, EU and U.S.A. only.

PM620 and PM622 Cold Planers

For more complete information on Cat products, dealer services, and industry solutions, visit us on the web at www.cat.com

QEHQ1978-07 (05-2019)

©2019 Caterpillar Inc. All rights reserved

Materials and specifications are subject to change without notice. Featured machines in photos may include additional equipment. See your Cat dealer for available options.

CAT, CATERPILLAR, LET'S DO THE WORK, their respective logos, "Caterpillar Yellow", the "Power Edge" trade dress as well as corporate and product identity used herein, are trademarks of Caterpillar and may not be used without permission.

