



Cat[®] 305 CR

MINI EXCAVATOR

FEATURES:

The Cat[®] 305 CR Mini Excavator delivers power and performance in a compact size to help you work in a wide range of applications.

ALL DAY COMFORT

- Choose either a canopy (not available in some regions) or a sealed and pressurized cab which can be equipped with air conditioning, adjustable wrist rests, and a suspension seat to help keep you working comfortably all day long.

EASY TO OPERATE

- Controls are easy to use and the intuitive Next Generation LCD monitor provides easy to read machine information. An advanced touchscreen monitor can also be equipped as an upgrade option.

STICK STEER TRAVEL MODE

- Moving around the job site is even easier with the Cat Stick Steer option. Easily switch from traditional travel controls with levers and pedals to joystick controls to move the machine and to operate the blade. The benefit of less effort and improved control is in your hands!

BIG PERFORMANCE IN A COMPACT DESIGN

- Strong lift and dig performance helps you get the job done faster. The compact radius design lets you access and work in the tightest areas. Dozer float allows for easy clean up. An angle blade is also an option for finished grading and easier backfilling applications.

SAFETY ON THE JOB SITE

- Your safety is our top priority. The Cat mini excavator is designed to help keep you safe on the job. Courtesy work lights and a fluorescent retractable seat belt are just a couple of the safety features we've built into the machine.

SIMPLE SERVICE FOR LESS DOWNTIME

- Maintenance is quick and easy on the Cat mini excavator. Routine check points are easy to access at ground level through the side doors.

LOWER OPERATING COSTS

- Equipped with features such as auto idle, auto engine shutdown, and efficient hydraulics with a variable displacement pump, the Cat mini excavator was designed with reducing your operating costs in mind.

UNMATCHED DEALER SUPPORT

- Your Cat dealer is here to help you reach your business goals. From providing equipment solutions to operator training to service needs and beyond, your Cat dealer is ready to help.

Specifications

Engine

Engine Model	C1.7 Turbo	
Net Power @ 2,400 rpm		
ISO 9249, 80/1269/EEC	33.6 kW	45.0 hp
Gross Power @ 2,400 rpm		
SAE J1995:2014	36.1 kW	48.4 hp
Bore	84.0 mm	3.3 in
Stroke	100.0 mm	3.9 in
Displacement	1.662 L	101 in ³

- Meets EU Stage V emission standards.
- Net power advertised is the power available at the flywheel when the engine is at rated speed and rated power when the engine is installed with the factory configured fan, air intake system, exhaust system, and alternator with a minimum alternator load.

Weights

Minimum Operating Weight with Canopy*	5006 kg	11,038 lb
Maximum Operating Weight with Canopy**	5665 kg	12,491 lb
Minimum Operating Weight with Cab*	5105 kg	11,257 lb
Maximum Operating Weight with Cab**	5764 kg	12,710 lb

- *Minimum Weight is based on rubber tracks, operator, full fuel tank, standard stick, straight blade, no bucket and no extra counterweight.
- **Maximum Weight is based on steel tracks with pads, operator, full fuel tank, long stick, straight blade, extra counterweight and no bucket.



305 CR Mini Excavator

Weight Increase from Minimum Configuration

Counterweight	242 kg	534 lb
Long Stick	34 kg	75 lb
Steel Tracks with Pads	375 kg	827 lb
Angle Blade	92 kg	203 lb

Travel System

Travel Speed – High	5.0 km/h	3.1 mph
Travel Speed – Low	2.8 km/h	1.7 mph
Maximum Traction Force – High Speed	24.7 kN	5,553 lbf
Maximum Traction Force – Low Speed	50.5 kN	11,353 lbf
Ground Pressure – Minimum Weight	27.3 kPa	4.0 psi
Ground Pressure – Maximum Weight	32.2 kPa	4.7 psi
Gradeability (maximum)	30 degrees	

Service Refill Capacities

Cooling System	11.0 L	2.9 gal
Engine Oil	6.0 L	1.6 gal
Fuel Tank	63.0 L	17.0 gal
Hydraulic Tank	60.0 L	16.0 gal
Hydraulic System	75.0 L	20.0 gal

Hydraulic System

Load Sensing Hydraulics with Variable Displacement Piston Pump		
Pump Flow @ 2,400 rpm	133 L/min	35 gal/min
Operating Pressure – Equipment	265 bar	3,843 psi
Operating Pressure – Travel	265 bar	3,843 psi
Operating Pressure – Swing	200 bar	2,901 psi
Auxiliary Circuit – Primary		
Flow*	80 L/min	21 gal/min
Pressure*	265 bar	3,843 psi
Auxiliary Circuit – Secondary		
Flow*	28 L/min	7.0 gal/min
Pressure*	265 bar	3,843 psi
Digging Force – Stick (standard)	28.3 kN	6,362 lbf
Digging Force – Stick (long)	25.2 kN	5,665 lbf
Digging Force – Bucket	49.2 kN	11,061 lbf

*Flow and pressure are not combinable. Under load, as flow rises pressure goes down.

Swing System

Machine Swing Speed	9.0 rpm
Boom Swing – Left	72 Degrees
Boom Swing – Right	50 Degrees

Blade

Width (Straight)	1980 mm	78.0 in
Height (Straight)	390 mm	15.4 in
Width (Angle)	1980 mm	78.0 in
Height (Angle)	400 mm	15.7 in
Angle Blade – Left	25 degrees	
Angle Blade – Right	25 degrees	

Certification – Cab and Canopy

Roll Over Protective Structure (ROPS)	ISO 12117-2:2008
Tip Over Protective Structure (TOPS)	ISO 12117:1997
Top Guard	ISO 10262:1998 Level I

Sound

Operator Sound Pressure Level (ISO 6396:2008)	76 dB(A)
Exterior Sound Power Level (ISO 6395:2008)	97 dB(A)

• European Union Directive “2000/14/EC”

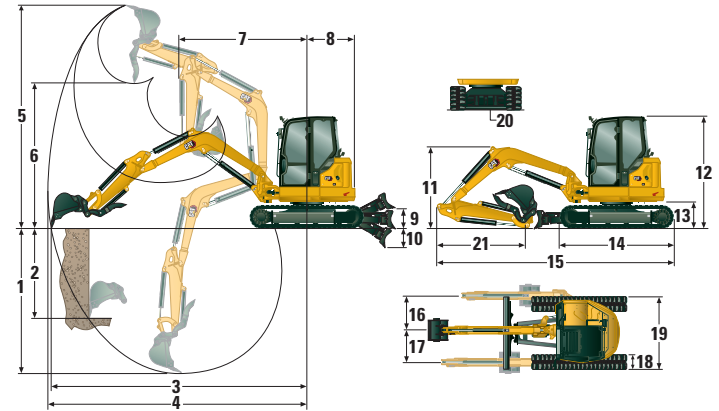

Dimensions

	Standard Stick	Long Stick
1 Dig Depth	3420 mm (134.6 in)	3670 mm (144.5 in)
2 Vertical Wall	2335 mm (91.9 in)	2560 mm (100.8 in)
3 Maximum Reach at Ground Level	5590 mm (220.1 in)	5835 mm (229.7 in)
4 Maximum Reach	5755 mm (226.6 in)	5990 mm (235.8 in)
5 Maximum Dig Height	5215 mm (205.3 in)	5355 mm (210.8 in)
6 Maximum Dump Clearance	3700 mm (145.7 in)	3845 mm (151.4 in)
7 Boom in Reach	2570 mm (101.2 in)	2580 mm (101.6 in)
8 Tail Swing		
without Counterweight	1095 mm (43.1 in)	1095 mm (43.1 in)
with Counterweight	1200 mm (47.2 in)	1200 mm (47.2 in)
9 Maximum Blade Height	400 mm (15.7 in)	400 mm (15.7 in)
10 Maximum Blade Depth	650 mm (25.6 in)	650 mm (25.6 in)
11 Boom Height in Shipping Position	1820 mm (71.7 in)	1895 mm (74.6 in)
12 Overall Shipping Height	2550 mm (100.4 in)	2550 mm (100.4 in)
13 Swing Bearing Height	619 mm (24.4 in)	619 mm (24.4 in)
14 Overall Undercarriage Length	2585 mm (101.8 in)	2585 mm (101.8 in)
15 Overall Shipping Length†	5305 mm (208.9 in)	5340 mm (210.2 in)
16 Boom Swing Right	865 mm (34.1 in)	865 mm (34.1 in)
17 Boom Swing Left	615 mm (24.2 in)	615 mm (24.2 in)
18 Track Belt/Shoe Width	400 mm (15.7 in)	400 mm (15.7 in)
19 Track Width	1980 mm (78.0 in)	1980 mm (78.0 in)
20 Ground Clearance	335 mm (13.2 in)	335 mm (13.2 in)
21 Stick Length	1351 mm (53.2 in)	1601 mm (63.0 in)

†Overall Shipping Length depends on blade position during shipment.

Cab

Lift Capacities – Minimum Configuration			Lift Point Radius – 3 m (9.8 ft)			Lift Point Radius – 4.5 m (14.8 ft)			Lift Point Radius (Maximum)			m (ft)
			Over Front			Over Front			Over Front			
			Blade Down	Blade Up	Over Side	Blade Down	Blade Up	Over Side	Blade Down	Blade Up	Over Side	
4.5 m (14.8 ft)	Standard Stick	kg (lb)										
	Long Stick	kg (lb)										
3 m (9.8 ft)	Standard Stick	kg (lb)				*1206 (*2,659)	908 (2,002)	721 (1,590)	*949 (*2,093)	*949 (*2,093)	*949 (*2,093)	3.63 (11.9)
	Long Stick	kg (lb)				*1249 (*2,754)	903 (1,991)	714 (1,574)	*778 (*1,715)	*778 (*1,715)	*778 (*1,715)	4.55 (14.9)
1.5 m (4.9 ft)	Standard Stick	kg (lb)	*2587 (*5,704)	1641 (3,618)	1257 (2,772)	*1615 (*3,561)	882 (1,945)	696 (1,535)	*975 (*2,150)	759 (1,674)	599 (1,321)	4.96 (16.3)
	Long Stick	kg (lb)	*2236 (*4,930)	1641 (3,618)	1255 (2,767)	*1508 (*3,325)	868 (1,914)	682 (1,504)	*794 (*1,751)	*794 (*1,751)	*794 (*1,751)	5.19 (17.0)
0 m (0 ft)	Standard Stick	kg (lb)	*3260 (*7,188)	1559 (3,438)	1183 (2,609)	*1825 (*4,024)	855 (1,885)	670 (1,477)	*1190 (*2,624)	787 (1,735)	619 (1,365)	4.77 (15.6)
	Long Stick	kg (lb)	*3193 (*7,041)	1534 (3,382)	1158 (2,553)	*1781 (*3,927)	833 (1,837)	648 (1,429)	*953 (*2,101)	711 (1,568)	555 (1,224)	5.02 (16.5)

Minimum Weight includes cab, rubber tracks, no counterweight, operator, full fuel tank and straight blade.

Lift Capacities – Maximum Configuration			Lift Point Radius – 3 m (9.8 ft)			Lift Point Radius – 4.5 m (14.8 ft)			Lift Point Radius (Maximum)			m (ft)
			Over Front			Over Front			Over Front			
			Blade Down	Blade Up	Over Side	Blade Down	Blade Up	Over Side	Blade Down	Blade Up	Over Side	
4.5 m (14.8 ft)	Standard Stick	kg (lb)										
	Long Stick	kg (lb)										
3 m (9.8 ft)	Standard Stick	kg (lb)				*1206 (*2,659)	*1206 (*2,659)	911 (2,009)	*949 (*2,093)	*949 (*2,093)	*949 (*2,093)	3.63 (11.9)
	Long Stick	kg (lb)				*1249 (*2,754)	*1249 (*2,754)	904 (1,993)	*778 (*1,715)	*778 (*1,715)	*778 (*1,715)	4.81 (15.8)
1.5 m (4.9 ft)	Standard Stick	kg (lb)	*2587 (*5,704)	1953 (4,306)	1579 (3,482)	*1615 (*3,561)	1059 (2,335)	886 (1,954)	*975 (*2,150)	*975 (*2,150)	*975 (*2,150)	4.96 (16.3)
	Long Stick	kg (lb)	*2236 (*4,930)	1953 (4,306)	1577 (3,477)	*1508 (*3,325)	1045 (2,304)	872 (1,923)	*794 (*1,751)	*794 (*1,751)	*794 (*1,751)	5.19 (17.0)
0 m (0 ft)	Standard Stick	kg (lb)	*3260 (*7,188)	1871 (4,126)	1505 (3,319)	*1825 (*4,024)	1032 (2,276)	860 (1,896)	*1190 (*2,624)	951 (2,097)	795 (1,783)	4.77 (15.6)
	Long Stick	kg (lb)	*3193 (*7,041)	1847 (4,073)	1480 (3,263)	*1781 (*3,927)	1010 (2,227)	838 (1,848)	*953 (*2,101)	*953 (*2,101)	*953 (*2,101)	5.02 (16.5)

Maximum Weight includes cab, steel tracks with pads, counterweight, operator, full fuel tank and angle blade.

Canopy

Lift Capacities – Minimum Configuration			Lift Point Radius – 3 m (9.8 ft)			Lift Point Radius – 4.5 m (14.8 ft)			Lift Point Radius (Maximum)			m (ft)
			Over Front			Over Front			Over Front			
			Blade Down	Blade Up	Over Side	Blade Down	Blade Up	Over Side	Blade Down	Blade Up	Over Side	
4.5 m (14.8 ft)	Standard Stick	kg (lb)										
	Long Stick	kg (lb)										
3 m (9.8 ft)	Standard Stick	kg (lb)				*1206 (*2,659)	887 (1,956)	705 (1,555)	*949 (*2,093)	*949 (*2,093)	*949 (*2,093)	3.63 (11.9)
	Long Stick	kg (lb)				*1249 (*2,754)	881 (1,943)	698 (1,539)	*778 (*1,715)	*778 (*1,715)	*778 (*1,715)	4.81 (15.8)
1.5 m (4.9 ft)	Standard Stick	kg (lb)	*2587 (*5,704)	1603 (3,535)	1230 (2,712)	*1615 (*3,561)	861 (1,899)	680 (1,499)	*975 (*2,150)	740 (1,632)	585 (1,290)	4.96 (16.3)
	Long Stick	kg (lb)	*2236 (*4,930)	1603 (3,535)	1228 (2,708)	*1508 (*3,325)	847 (1,868)	665 (1,466)	*794 (*1,751)	*794 (*1,482)	*794 (*1,482)	5.19 (17.0)
0 m (0 ft)	Standard Stick	kg (lb)	*3260 (*7,188)	1521 (3,354)	1155 (2,547)	*1825 (*4,024)	833 (1,837)	654 (1,442)	*1190 (*2,624)	767 (1,691)	603 (1,330)	4.77 (15.6)
	Long Stick	kg (lb)	*3193 (*7,041)	1497 (3,301)	1131 (2,494)	*1781 (*3,927)	812 (1,790)	632 (1,394)	*953 (*2,101)	692 (1,526)	541 (1,193)	5.02 (16.5)

Minimum Weight includes canopy, rubber tracks, no counterweight, operator, full fuel tank and straight blade.

Lift Capacities – Maximum Configuration			Lift Point Radius – 3 m (9.8 ft)			Lift Point Radius – 4.5 m (14.8 ft)			Lift Point Radius (Maximum)			m (ft)
			Over Front			Over Front			Over Front			
			Blade Down	Blade Up	Over Side	Blade Down	Blade Up	Over Side	Blade Down	Blade Up	Over Side	
4.5 m (14.8 ft)	Standard Stick	kg (lb)										
	Long Stick	kg (lb)										
3 m (9.8 ft)	Standard Stick	kg (lb)				*1206 (*2,659)	*1206 (*2,659)	895 (1,973)	*949 (*2,093)	*949 (*2,093)	*949 (*2,093)	3.63 (11.9)
	Long Stick	kg (lb)				*1249 (*2,754)	1059 (2,335)	888 (1,958)	*778 (*1,715)	*778 (*1,715)	*778 (*1,715)	4.81 (15.8)
1.5 m (4.9 ft)	Standard Stick	kg (lb)	*2587 (*5,704)	1915 (4,223)	1552 (3,422)	*1615 (*3,561)	1038 (2,289)	870 (1,918)	*975 (*2,150)	*975 (*2,150)	*975 (*2,150)	4.96 (16.3)
	Long Stick	kg (lb)	*2236 (*4,930)	1915 (4,223)	1550 (3,418)	*1508 (*3,325)	1024 (2,258)	855 (1,885)	*794 (*1,751)	*794 (*1,751)	*794 (*1,751)	5.19 (17.0)
0 m (0 ft)	Standard Stick	kg (lb)	*3260 (*7,188)	1833 (4,042)	1477 (3,257)	*1825 (*4,024)	1010 (2,227)	844 (1,861)	*1190 (*2,624)	931 (2,053)	780 (1,720)	4.77 (15.6)
	Long Stick	kg (lb)	*3193 (*7,041)	1809 (3,989)	1453 (3,204)	*1781 (*3,927)	989 (2,181)	822 (1,813)	*953 (*2,101)	*953 (*2,101)	*953 (*2,101)	5.02 (16.5)

Maximum Weight includes canopy, steel tracks with pads, counterweight, operator, full fuel tank and angle blade.

*The above loads are in compliance with hydraulic excavator lift capacity rating standard ISO 10567:2007 and they do not exceed 87% of hydraulic lifting capacity or 75% of tipping capacity. The excavator bucket weight is not included on this chart.

305 CR Mini Excavator

Standard and Optional Equipment

Standard and optional equipment may vary. Consult your Cat dealer for details.

	Standard	Optional		Standard	Optional
ENGINE			OPERATOR ENVIRONMENT (continued)		
Cat® C1.7 Turbo Engine (EU Stage V)	✓		Next Generation Color LCD Monitor (IP66)	✓	
Automatic Engine Idle	✓		– Fuel Level and Coolant Temperature Gauges	✓	
Automatic Engine Shutdown	✓		– Maintenance and Machine Monitoring	✓	
Automatic Two Speed Travel	✓		– Performance and Machine Adjustments	✓	
Fuel Water Separator	✓		– Numeric Security Code	✓	
Power on Demand (not available in all regions)	✓		– Multiple Languages	✓	
Variable Displacement Piston Pump	✓		– Hour Meter with Wake Up Switch	✓	
Load Sensing/Flow Sharing Hydraulics	✓		– Jog Dial (cab only)	✓	
HYDRAULICS			Next Generation Advanced Monitor		✓
Smart Tech Electronic Pump	✓		– Touch Screen		✓
Accumulator	✓		– Site Reference System		✓
Automatic Swing Brake	✓		– High Definition Camera Capable (IP68 and IP69K)		✓
Auxiliary Hydraulic Lines	✓		– Numeric Security Code		✓
One and Two Way Auxiliary Flow	✓		UNDERCARRIAGE		
Continuous Auxiliary Flow	✓		Rubber Belt (400 mm/15.7 in)	✓	
Auxiliary Line Quick Disconnects	✓		Steel Track (400 mm/15.7 in)		✓
OPERATOR ENVIRONMENT			Steel Track with Rubber Pads		✓
Canopy or Cab (Canopy not available in some regions)	✓		Dozer Straight Blade	✓	
Cab with Air Conditioning		✓	Dozer Blade Float	✓	
Cab with Heater		✓	Angle Blade		✓
Top Guard ISO 10262:1998 Level I	✓		Tie Downs on Track Frame	✓	
ROPS – ISO 12117-2:2008	✓		BOOM, STICK AND LINKAGES		
TOPS – ISO 12117:1997	✓		One Piece Boom (2716 mm/106.9 in)	✓	
Stick Steer Mode	✓		Standard Stick (1351 mm/53.2 in)	✓	
Travel Cruise Control	✓		Long Stick (1601 mm/63.0 in)		✓
Control Pattern Changer (optional in some regions)	✓		Front Shovel Capable	✓	
Adjustable Wrist Rests	✓		Pin-On	✓	
Washable Floor Mat	✓		Dual Lock Manual Coupler		✓
Travel Pedals and Hand Levers	✓		Hydraulic Coupler		✓
No Travel Pedals and Hand Levers (optional in some regions)		✓	Thumb Ready	✓	
Machine Security	✓		Certified Lifting Eye	✓	
Standard Key with Pass Code	✓		Attachments including Couplers, Thumbs, Buckets, Augers and Hammers		✓
Push to Start with Key Fob/Pass Code		✓	2nd Auxiliary Hydraulic Lines		✓
Fabric Suspension Seat (Cab only)	✓		Bucket Divert Lines		✓
Vinyl Suspension Seat (Canopy only)	✓		Boom Lowering Check Valve		✓
Hydraulic Lockout – All Controls	✓		Stick Lowering Check Valve		✓
Retractable High Visibility Seat Belt (75 mm/3 in)	✓		Hydraulic Quick Coupler Lines		✓
Coat Hook	✓		ELECTRICAL		
Cup Holder	✓		12 Volt Battery	✓	
Storage Pocket	✓		Software (machine and monitor)	✓	
Skylight	✓		Maintenance Free Battery	✓	
Mounting Bosses for Front	✓		Battery Disconnect	✓	
Signaling/Warning Horn	✓		12 Volt Power Socket	✓	
Interior Light (Cab only)	✓		Product Link™ PL243 (regulations apply)		✓
Boom Light, Halogen (not available in all regions)	✓		Product Link PLE643 (regulations apply)		✓
LED Front Lights		✓	Travel Alarm (optional in some regions)	✓	
LED Front and Rear Lights		✓	GUARDING		
LED Boom Light		✓	Polycarbonate Half Height Front Guard (Canopy only)		✓
Utility Space for Mobile Phone	✓		Polycarbonate Front Guard (ISO 10262:1998 Level I and EN356 P5A)		✓
Mirrors, Left, Right and Rear		✓	Heavy Duty Front Guard ISO 10262:1998 Level II		✓
Camera		✓	Heavy Duty Top Guard 10262:1998 Level II (Cab only)		✓
Radio – Bluetooth®, Auxiliary, Microphone, USB (charging only) (Cab only)		✓	OTHER		
			Bio Oil Capable		✓
			Eco Drain		✓
			Water Jacket Heater		✓
			Counterweight (242 kg/534 lb)		✓

For more complete information on Cat products, dealer services, and industry solutions, visit us on the web at www.cat.com

© 2021 Caterpillar
All rights reserved

Materials and specifications are subject to change without notice. Featured machines in photos may include additional equipment. See your Cat dealer for available options.

CAT, CATERPILLAR, LET'S DO THE WORK, their respective logos, "Caterpillar Corporate Yellow," the "Power Edge" and Cat "Modern Hex" trade dress as well as corporate and product identity used herein, are trademarks of Caterpillar and may not be used without permission.

AEHQ8394 (09-2021)
Build Number: 07A
(Europe,
Australia/New Zealand)

