

Image shown may not reflect actual engine

SPECIFICATIONS

V-12, 4-Stroke-Cycle-Diesel

Emissions EPA Tier 2 compliant*, IMO compliant
EU Stage 3A Inland Waterway
accepted as equivalent CCNR Stage II

Displacement 51.8 L (3161 cu. in.)

Rated Engine Speed 1600

Bore 170.0 mm (6.7 in.)

Stroke 190.0 mm (7.48 in.)

Aspiration Turbocharged-Aftercooled
Governor ADEM™ A3

Cooling System Heat Exchanger

Weight, Net Dry
(approx) 6532-7411 kg (14,400-16,340 lb)

Refill Capacity

Cooling System (approx) 156.8 L (41.4 gal)

Lube Oil System 625 L (165 gal)

Oil Change Interval 1000 hr
Caterpillar Diesel Engine Oil 10W30 or 15W40
Deep Sump Oil Pan

Rotation (from flywheel end) Counterclockwise

Flywheel and Flywheel Housing SAE No. 00

Flywheel Teeth 183

3512C Propulsion 512DM60 (standard)
512DM61 (reverse)

A rating

1420 mhp (1400 bhp) 1044 kW @ 1600 rpm (DM8466)

B rating

1521 mhp (1500 bhp) 1118 kW @ 1600 rpm (DM8467)

C rating

1622 mhp (1600 bhp) 1194 kW @ 1600 rpm (DM8468)

*EPA Tier 2 certification in process at time of print

STANDARD ENGINE EQUIPMENT

Air Inlet System

Corrosion resistant separate circuit freshwater aftercooled, powercore air cleaner

Control System

Dual Caterpillar® A3 Electronic Control Unit (ECU) LH with electronic unit injector fuel system rigid wiring harness (10 amp DC power required to drive ECU)

Cooling System

Gear-driven centrifugal auxiliary sea water pump, gear-driven centrifugal jacket water pump, expansion tank for commercial engines, coolant shunt tank on lightweight engines, engine oil cooler, thermostats and housing.

ECU Functions

Programmable low idle, SAEJ1939 data link, Cat® data link, engine diagnostics, general alarm relay, programmable parameters (system application and tattletales), Caterpillar ET service tool interface, remote shutdown, shutdown notify, load feedback, overspeed shutdown, overspeed verify

Exhaust System

Dry gas-tight exhaust manifolds with heat shields, dual turbochargers with watercooled bearings and heat shield. Wastegate on select ratings.

Fuel System

Electronically controlled unit injectors, simplex fuel filter with service indicators, fuel transfer pump

Instrumentation

Marine Power Display of: Engine oil pressure, engine water temperature, fuel pressure, engine speed, fuel consumption, overspeed shutdown notification light, prelube and shutdown override

Lube System

Gear-driven pump, top-mounted dual crankcase breather groups, simplex oil filter, oil filler and dipstick.

Power Take-Offs

Accessory drive, two-sided front housing

Protection System

Emergency stop pushbutton, safety shutoff, oil pressure, and water temperature

General

Two lifting eyes mounted to cylinder heads, Caterpillar yellow paint, parts books and maintenance manuals, shrink-wrap.

ISO Certification

Factory-designed systems built at Caterpillar ISO 9001:2000 certified facilities.

MARINE ENGINE PERFORMANCE

3512C DITA
1420 mhp (1400 bhp) 1044 bkW @ 1600 rpm
A Rating — DM8466-00

Aftercooler Temperature 48°C (118°F)

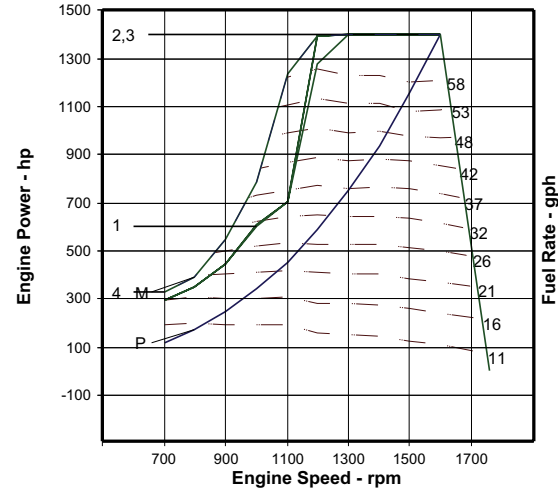
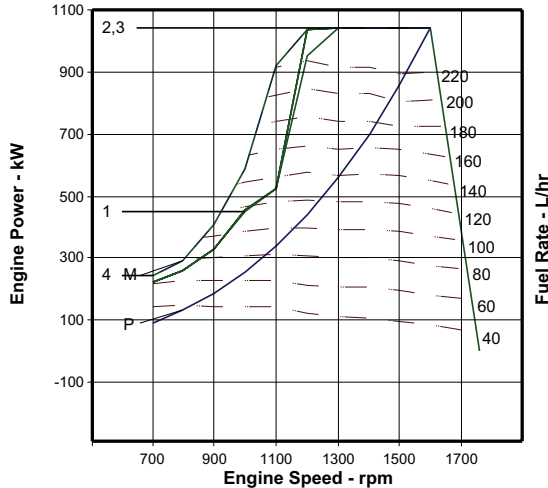

Performance Data

Performance Data

	Engine Speed rpm	Engine Power kW	BSFC g/kW-hr	Fuel Rate L/hr	Boost Press kPa Gauge	Intake Air Flow m³/min	Exh Manif Temp °C	Exh Gas Flow m³/min
Zone Limit	1600	1044	203	252.0	207.6	105.8	519	224.7
Curve: 1	1400	1044	200	248.9	204.7	95.4	551	214.0
	1200	953	196	223.2	159.7	70.9	625	176.1
	1000	452	216	116.6	46.9	33.1	624	87.3
	800	260	222	68.6	16.2	20.6	529	48.1
	700	222	231	60.9	11.6	17.9	514	40.9
Zone Limit	1600	1044	203	252.0	0.0	105.8	519	224.7
Curve: 2	1400	1044	200	248.9	0.0	95.4	551	214.0
	1200	1040	195	241.9	0.0	75.9	630	189.2
	1000	456	216	117.6	0.0	33.2	627	87.9
	800	260	222	68.6	0.0	20.6	529	48.1
	700	222	231	60.9	0.0	17.9	514	40.9
Zone Limit	1600	1044	203	252.0	207.6	105.8	519	224.7
Curve: 3	1400	1044	200	248.9	204.7	95.4	551	214.0
	1200	1040	195	241.9	178.2	75.9	630	189.2
	1000	456	216	117.6	47.5	33.2	627	87.9
	800	260	222	68.6	16.2	20.6	529	48.1
	700	222	231	60.9	11.6	17.9	514	40.9
Zone Limit	1600	1044	203	252.0	207.6	105.8	519	224.7
Curve: 4	1400	1044	200	248.9	204.7	95.4	551	214.0
	1200	1040	195	241.9	178.2	75.9	630	189.2
	1000	587	215	150.5	72.3	39.0	699	108.6
	800	291	224	77.8	19.8	21.5	586	52.9
	700	244	233	67.6	13.8	18.2	563	43.8
Max Power Curve: M	1600	1044	203	252.0	207.6	105.8	519	224.7
	1400	1044	200	248.9	204.7	95.4	551	214.0
	1200	1040	195	241.9	178.2	75.9	630	189.2
	1000	587	215	150.5	72.3	39.0	699	108.6
	800	291	224	77.8	19.8	21.5	586	52.9
	700	244	233	67.6	13.8	18.2	563	43.8
Prop Demand Curve: P	1600	1044	203	252.0	207.6	105.8	519	224.7
	1400	699	204	169.7	122.3	69.3	518	151.5
	1200	440	209	109.9	54.4	41.6	520	95.1
	1000	255	220	67.0	20.8	27.0	439	57.5
	800	131	231	35.9	6.3	18.2	318	31.6
	700	87	258	26.9	3.4	16.3	265	25.3

	Engine Speed rpm	Engine Power hp	BSFC lb/hp-hr	Fuel Rate gph	Boost Press in-hg Gauge	Intake Air Flow cfm	Exh Manif Temp °F	Exh Gas Flow cfm
Zone Limit	1600	1400	.334	66.6	61.5	3736	966	7935
Curve: 1	1400	1400	.329	65.8	60.6	3369	1024	7557
	1200	1278	.322	59.0	47.3	2504	1157	6219
	1000	606	.355	30.8	13.9	1169	1155	3083
	800	349	.365	18.1	4.8	727	984	1699
	700	298	.380	16.1	3.4	632	957	1444
Zone Limit	1600	1400	.334	66.6	0.0	3736	966	7935
Curve: 2	1400	1400	.329	65.8	0.0	3369	1024	7557
	1200	1395	.321	63.9	0.0	2680	1166	6682
	1000	612	.355	31.1	0.0	1172	1161	3104
	800	349	.365	18.1	0.0	727	984	1699
	700	298	.380	16.1	0.0	632	957	1444
Zone Limit	1600	1400	.334	66.6	61.5	3736	966	7935
Curve: 3	1400	1400	.329	65.8	60.6	3369	1024	7557
	1200	1395	.321	63.9	52.8	2680	1166	6682
	1000	612	.355	31.1	14.1	1172	1161	3104
	800	349	.365	18.1	4.8	727	984	1699
	700	298	.380	16.1	3.4	632	957	1444
Zone Limit	1600	1400	.334	66.6	61.5	3736	966	7935
Curve: 4	1400	1400	.329	65.8	60.6	3369	1024	7557
	1200	1395	.321	63.9	52.8	2680	1166	6682
	1000	787	.353	39.8	21.4	1377	1290	3835
	800	390	.368	20.6	5.9	759	1087	1868
	700	327	.383	17.9	4.1	643	1045	1547
Max Power Curve: M	1600	1400	.334	66.6	61.5	3736	966	7935
	1400	1400	.329	65.8	60.6	3369	1024	7557
	1200	1395	.321	63.9	52.8	2680	1166	6682
	1000	787	.353	39.8	21.4	1377	1290	3835
	800	390	.368	20.6	5.9	759	1087	1868
	700	327	.383	17.9	4.1	643	1045	1547
Prop Demand Curve: P	1600	1400	.334	66.6	61.5	3736	966	7935
	1400	937	.335	44.8	36.2	2447	964	5350
	1200	590	.344	29.0	16.1	1469	968	3358
	1000	342	.362	17.7	6.2	953	822	2031
	800	176	.380	9.5	1.9	643	604	1116
	700	117	.424	7.1	1.0	576	509	893

Brake Mean Effective Pressure 1513 kPa
Heat Rejection to Coolant (total) 428 kW
Heat Rejection to Aftercooler 267 kW
Heat Rejection to Exhaust (total) 841 kW
Heat Rejection to Atmosphere from Engine 97 kW

Brake Mean Effective Pressure 219 psi
Heat Rejection to Coolant (total) 24340 btu/min
Heat Rejection to Aftercooler 15184 btu/min
Heat Rejection to Exhaust (total) 47828 btu/min
Heat Rejection to Atmosphere from Engine 5516 btu/min

MARINE ENGINE PERFORMANCE

3512C DITA

1521 mhp (1500 bhp) 1118 bkW @ 1600 rpm

B Rating — DM8467-00

Aftercooler Temperature 48°C (118°F)

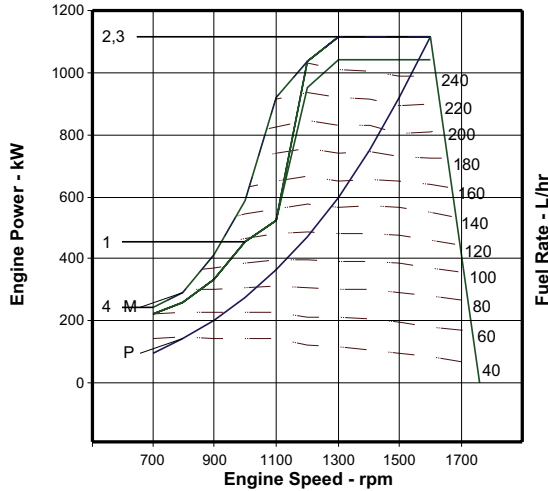

Performance Data

	Engine Speed rpm	Engine Power kW	BSFC g/kW-hr	Fuel Rate L/hr	Boost Press kPa Gauge	Intake Air Flow m³/min	Exh Manif Temp °C	Exh Gas Flow m³/min
Zone	1600	1044	203	252.0	207.6	105.8	519	224.7
Limit	1400	1044	200	248.9	204.7	95.4	551	214.0
Curve: 1	1200	953	196	223.2	159.7	70.9	625	176.1
	1000	452	216	116.6	46.9	33.1	624	87.3
	800	260	222	68.6	16.2	20.6	529	48.1
	700	222	231	60.9	11.6	17.9	514	40.9
Zone	1600	1119	202	269.2	0.0	110.9	528	237.4
Limit	1400	1119	198	264.5	0.0	99.4	557	224.4
Curve: 2	1200	1040	195	241.9	0.0	75.9	630	189.2
	1000	456	216	117.6	0.0	33.2	627	87.9
	800	260	222	68.6	0.0	20.6	529	48.1
	700	222	231	60.9	0.0	17.9	514	40.9
Zone	1600	1119	202	269.2	222.5	110.9	528	237.4
Limit	1400	1119	198	264.5	218.2	99.4	557	224.4
Curve: 3	1200	1040	195	241.9	178.2	75.9	630	189.2
	1000	456	216	117.6	47.5	33.2	627	87.9
	800	260	222	68.6	16.2	20.6	529	48.1
	700	222	231	60.9	11.6	17.9	514	40.9
Zone	1600	1119	202	269.2	222.5	110.9	528	237.4
Limit	1400	1119	198	264.5	218.2	99.4	557	224.4
Curve: 4	1200	1040	195	241.9	178.2	75.9	630	189.2
	1000	587	215	150.5	72.3	39.0	699	108.6
	800	291	224	77.8	19.8	21.5	586	52.9
	700	244	233	67.6	13.8	18.2	563	43.8
Max Power	1600	1119	202	269.2	222.5	110.9	528	237.4
Limit	1400	1119	198	264.5	218.2	99.4	557	224.4
Curve: M	1200	1040	195	241.9	178.2	75.9	630	189.2
	1000	587	215	150.5	72.3	39.0	699	108.6
	800	291	224	77.8	19.8	21.5	586	52.9
	700	244	233	67.6	13.8	18.2	563	43.8
Prop Demand	1600	1119	202	269.2	222.5	110.9	528	237.4
Limit	1400	749	203	181.2	135.6	73.5	524	160.9
Curve: P	1200	472	208	116.9	60.0	43.2	535	99.8
	1000	273	220	71.5	22.8	27.5	461	60.2
	800	140	228	38.0	6.9	18.3	332	32.6
	700	94	254	28.4	3.7	16.3	276	26.0

Brake Mean Effective Pressure	1621 kPa
Heat Rejection to Coolant (total)	449 kW
Heat Rejection to Aftercooler	297 kW
Heat Rejection to Exhaust (total)	895 kW
Heat Rejection to Atmosphere from Engine	99 kW

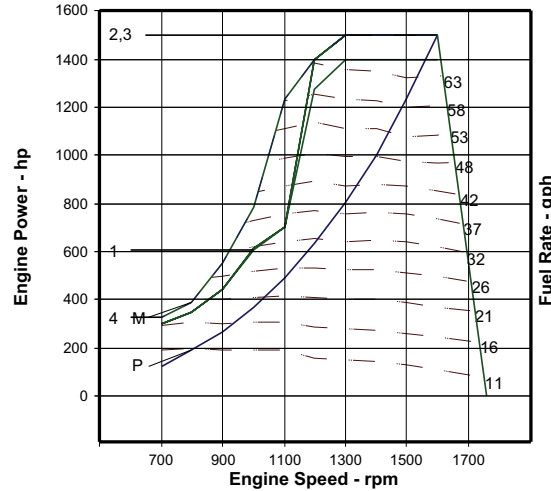

Performance Data

	Engine Speed rpm	Engine Power hp	BSFC lb/hp-hr	Fuel Rate gph	Boost Press in-Hg Gauge	Intake Air Flow cfm	Exh Manif Temp °F	Exh Gas Flow cfm
Zone	1600	1400	.334	66.6	61.5	3736	966	7935
Limit	1400	1400	.329	65.8	60.6	3389	1027	7557
Curve: 1	1200	1278	.322	59.0	47.3	2504	1157	6219
	1000	606	.355	30.8	13.9	1169	1155	3083
	800	349	.365	18.1	4.8	727	984	1699
	700	298	.380	16.1	3.4	632	957	1444
Zone	1600	1501	.332	71.1	0.0	3916	982	8384
Limit	1400	1501	.326	69.9	0.0	3510	1035	7925
Curve: 2	1200	1395	.321	63.9	0.0	2680	1166	6682
	1000	612	.355	31.1	0.0	1172	1161	3104
	800	349	.365	18.1	0.0	727	984	1699
	700	298	.380	16.1	0.0	632	957	1444
Zone	1600	1501	.332	71.1	65.9	3916	982	8384
Limit	1400	1501	.326	69.9	64.6	3510	1035	7925
Curve: 3	1200	1395	.321	63.9	52.8	2680	1166	6682
	1000	612	.355	31.1	14.1	1172	1161	3104
	800	349	.365	18.1	4.8	727	984	1699
	700	298	.380	16.1	3.4	632	957	1444
Zone	1600	1501	.332	71.1	65.9	3916	982	8384
Limit	1400	1501	.326	69.9	64.6	3510	1035	7925
Curve: 4	1200	1395	.321	63.9	52.8	2680	1166	6682
	1000	787	.353	39.8	21.4	1377	1290	3835
	800	390	.368	20.6	5.9	759	1087	1868
	700	327	.383	17.9	4.1	643	1045	1547
Max Power	1600	1501	.332	71.1	65.9	3916	982	8384
Limit	1400	1501	.326	69.9	64.6	3510	1035	7925
Curve: M	1200	1395	.321	63.9	52.8	2680	1166	6682
	1000	787	.353	39.8	21.4	1377	1290	3835
	800	390	.368	20.6	5.9	759	1087	1868
	700	327	.383	17.9	4.1	643	1045	1547
Prop Demand	1600	1501	.332	71.1	65.9	3916	982	8384
Limit	1400	1004	.334	47.9	40.2	2596	975	5682
Curve: P	1200	633	.342	30.9	17.8	1526	995	3524
	1000	366	.362	18.9	6.8	971	862	2126
	800	188	.375	10.0	2.0	646	630	1151
	700	126	.418	7.5	1.1	576	529	918

Brake Mean Effective Pressure	235 psi
Heat Rejection to Coolant (total)	25535 btu/min
Heat Rejection to Aftercooler	16890 btu/min
Heat Rejection to Exhaust (total)	50955 btu/min
Heat Rejection to Atmosphere from Engine	5630 btu/min

MARINE ENGINE PERFORMANCE

3512C DITA

1622 mhp (1600 bhp) 1194 bkW @ 1600 rpm
C Rating — DM8468-00

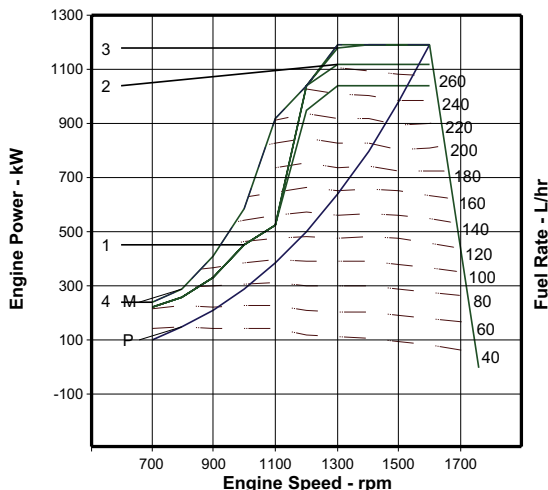

Performance Data

	Engine Speed rpm	Engine Power kW	BSFC g/kW-hr	Fuel Rate L/hr	Boost Press kPa Gauge	Intake Air Flow m³/min	Exh. Manif. Temp °C	Exh. Gas Flow m³/min
Zone Limit	1600	1044	203	252.0	207.6	105.8	519	224.7
Curve: 1	1400	1044	200	248.9	204.7	95.4	551	214.0
	1200	953	196	223.2	159.7	70.9	625	176.1
	1000	452	216	116.6	46.9	33.1	624	87.3
	800	260	222	68.6	16.2	20.6	529	48.1
	700	222	231	60.9	11.6	17.9	514	40.9
Zone Limit	1600	1119	202	269.2	0.0	110.9	528	237.4
Curve: 2	1400	1119	198	264.5	0.0	99.4	557	224.4
	1200	1040	195	241.9	0.0	75.9	630	189.2
	1000	456	216	117.6	0.0	33.2	627	87.9
	800	260	222	68.6	0.0	20.6	529	48.1
	700	222	231	60.9	0.0	17.9	514	40.9
Zone Limit	1600	1193	202	286.8	237.6	116.0	537	250.3
Curve: 3	1400	1193	197	279.7	231.6	103.2	563	234.1
	1200	1040	195	241.9	178.2	75.9	630	189.2
	1000	456	216	117.6	47.5	33.2	627	87.9
	800	260	222	68.6	16.2	20.6	529	48.1
	700	222	231	60.9	11.6	17.9	514	40.9
Zone Limit	1600	1193	202	286.8	237.6	116.0	537	250.3
Curve: 4	1400	1193	197	279.7	231.6	103.2	563	234.1
	1200	1040	195	241.9	178.2	75.9	630	189.2
	1000	587	215	150.5	72.3	39.0	699	108.6
	800	291	224	77.8	19.8	21.5	586	52.9
	700	244	233	67.6	13.8	18.2	563	43.8
Max Power	1600	1193	202	286.8	237.6	116.0	537	250.3
Curve: M	1400	1193	197	279.7	231.6	103.2	563	234.1
	1200	1040	195	241.9	178.2	75.9	630	189.2
	1000	587	215	150.5	72.3	39.0	699	108.6
	800	291	224	77.8	19.8	21.5	586	52.9
	700	244	233	67.6	13.8	18.2	563	43.8
Prop Demand	1600	1193	202	286.8	237.6	116.0	537	250.3
Curve: P	1400	799	202	192.7	148.7	77.7	530	170.3
	1200	503	207	123.9	65.9	44.8	548	104.7
	1000	291	219	76.1	25.0	28.0	483	62.9
	800	149	226	40.1	7.4	18.4	347	33.6
	700	100	251	29.9	3.9	16.4	287	26.7

Brake Mean Effective Pressure	1729 kPa
Heat Rejection to Coolant (total)	470 kW
Heat Rejection to Aftercooler	328 kW
Heat Rejection to Exhaust (total)	953 kW
Heat Rejection to Atmosphere from Engine	101 kW

Aftercooler Temperature 48°C (118°F)

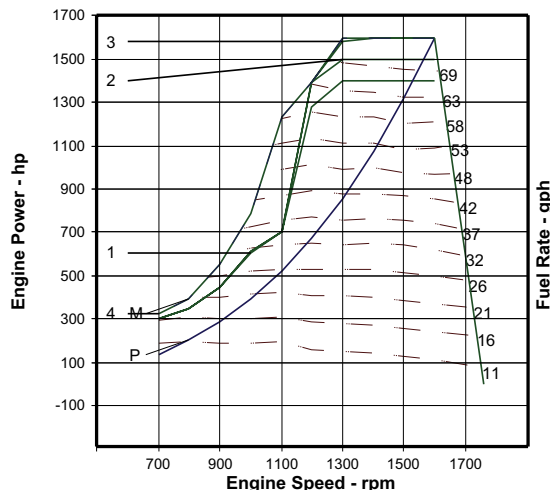

Performance Data

	Engine Speed rpm	Engine Power hp	BSFC lb/hp-hr	Fuel Rate gph	Boost Press in-hg Gauge	Intake Air Flow cfm	Exh. Manif. Temp °F	Exh. Gas Flow cfm
Zone Limit	1600	1400	.334	66.6	61.5	3736	966	7935
Curve: 1	1400	1400	.329	65.8	60.6	3369	1024	7557
	1200	1278	.322	59.0	47.3	2504	1157	6219
	1000	606	.355	30.8	13.9	1169	1155	3083
	800	349	.365	18.1	4.8	727	984	1699
	700	298	.380	16.1	3.4	632	957	1444
Zone Limit	1600	1501	.332	71.1	0.0	3916	982	8384
Curve: 2	1400	1501	.326	69.9	0.0	3510	1035	7925
	1200	1395	.321	63.9	0.0	2680	1166	6682
	1000	612	.355	31.1	0.0	1172	1161	3104
	800	349	.365	18.1	0.0	727	984	1699
	700	298	.380	16.1	0.0	632	957	1444
Zone Limit	1600	1600	.332	75.8	70.4	4097	999	8839
Curve: 3	1400	1600	.324	73.9	68.6	3644	1045	8267
	1200	1395	.321	63.9	52.8	2680	1166	6682
	1000	612	.355	31.1	14.1	1172	1161	3104
	800	349	.365	18.1	4.8	727	984	1699
	700	298	.380	16.1	3.4	632	957	1444
Zone Limit	1600	1600	.332	75.8	70.4	4097	999	8839
Curve: 4	1400	1600	.324	73.9	68.6	3644	1045	8267
	1200	1395	.321	63.9	52.8	2680	1166	6682
	1000	787	.353	39.8	21.4	1377	1290	3835
	800	390	.368	20.6	5.9	759	1087	1868
	700	327	.383	17.9	4.1	643	1045	1547
Max Power	1600	1600	.332	75.8	70.4	4097	999	8839
Curve: M	1400	1600	.324	73.9	68.6	3644	1045	8267
	1200	1395	.321	63.9	52.8	2680	1166	6682
	1000	787	.353	39.8	21.4	1377	1290	3835
	800	390	.368	20.6	5.9	759	1087	1868
	700	327	.383	17.9	4.1	643	1045	1547
Prop Demand	1600	1600	.332	75.8	70.4	4097	999	8839
Curve: P	1400	1071	.332	50.9	44.0	2744	986	6014
	1200	675	.340	32.7	19.5	1562	1018	3697
	1000	390	.360	20.1	7.4	989	901	2221
	800	200	.372	10.6	2.2	650	657	1187
	700	134	.413	7.9	1.2	579	549	943

Brake Mean Effective Pressure	251 psi
Heat Rejection to Coolant (total)	26729 btu/min
Heat Rejection to Aftercooler	18653 btu/min
Heat Rejection to Exhaust (total)	54197 btu/min
Heat Rejection to Atmosphere from Engine	5744 btu/min

DIMENSIONS

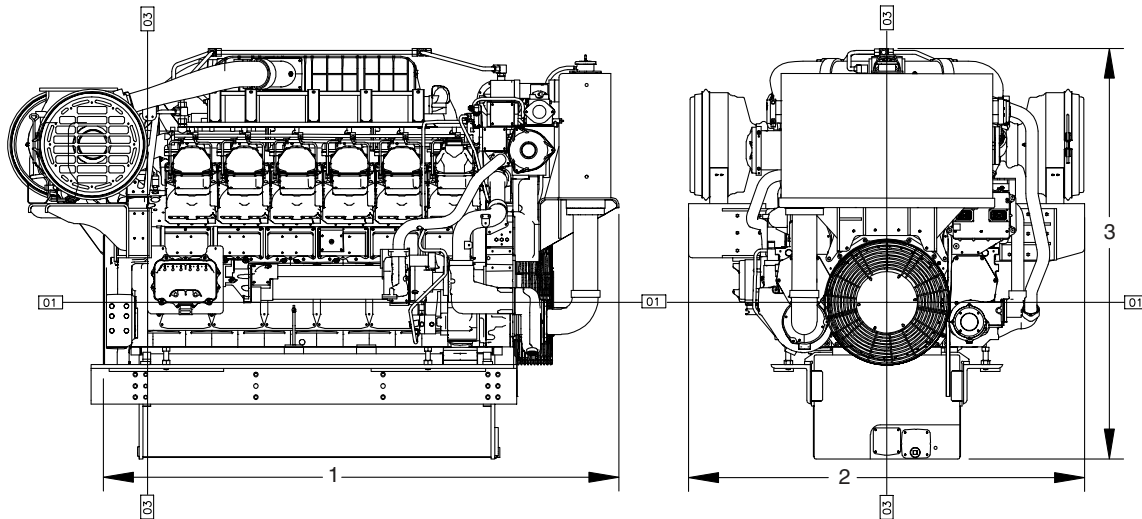

Engine Dimensions		
(1) Length to Flywheel Housing	2625.4 mm	103.4 in.
(2) Width	2036.9 mm	80.19 in.
(3) Height	2113.3 mm	83.2 in.
Weight, Net Dry (approx)	6532-7411 kg	14,400-16,340 lb

Note: Do not use for installation design. See general dimension drawings for detail (#340-3586, #340-3585).

For most current installation drawings, please visit <http://tmi.cat.com>

RATING DEFINITIONS AND CONDITIONS

A Rating (Unrestricted Continuous)

Typical applications: For vessels operating at rated load and rated speed up to 100% of the time without interruption or load cycling (80% to 100% load factor). Typical applications could include but are not limited to vessels such as freighters, tugboats, bottom trawlers, or deep river tugboats. Typical operation ranges from 5000 to 8000 hours per year.

B Rating (Heavy Duty)

Typical applications: For vessels operating at rated load and rated speed up to 80% of the time, or 10 hours out of 12, with some load cycling (40% to 80% load factor). Typical applications could include but are not limited to vessels such as mid-water trawlers, purse seiner, crew and supply boats, ferries, or towboats. Typical operation ranges from 3000 to 5000 hours per year.

C Rating (Maximum Continuous)

Typical applications: For vessels operating at rated load and rated speed up to 50% of the time, or 6 hours out of 12, with cyclical load and speed (20% to 80% load

factor). Typical applications could include but are not limited to vessels such as ferries, harbor tugs, fishing boats, offshore service boats, displacement hull yachts, or short trip coastal freighters. Typical operation ranges from 2000 to 4000 hours per year.

Power at declared engine speed is in accordance with ISO3046-1:2002E. Caterpillar maintains ISO9001:1994/QS-9000 approved engine test facilities to assure accurate calibration of test equipment. Electronically controlled engines are set at the factory at the advertised power corrected to standard ambient conditions. The published fuel consumption rates are in accordance with ISO3046-1.

Fuel rates are based on fuel oil of 35° API [16°C (60°F)] gravity having an LHV of 42 780 kJ/kg (18,390 Btu/lb) when used at 29°C (85°F) and weighing 838.9 g/L (7.001 lb/U.S. gal). Additional ratings may be available for specific customer requirements. Consult your Caterpillar representative for additional information.

Performance data is calculated in accordance with tolerances and conditions stated in this specification sheet and is only intended for purposes of comparison with other manufacturers' engines. Actual engine performance may vary according to the particular application of the engine and operating conditions beyond Caterpillar's control.

Power produced at the flywheel will be within standard tolerances up to 50°C (122°F) combustion air temperature measured at the air cleaner inlet, and fuel temperature up to 52°C (125°F) measured at the fuel filter base. Power rated in accordance with NMMA procedure as crankshaft power. Reduce crankshaft power by 3% for propeller shaft power.

CAT, CATERPILLAR, their respective logos, ADEM, "Caterpillar Yellow" and the POWER EDGE trade dress, as well as corporate and product identity used herein, are trademarks of Caterpillar and may not be used without permission.